

## TPG 256 A

Vacuum measurement and control unit  
for Compact Gauges

# MaxiGauge™

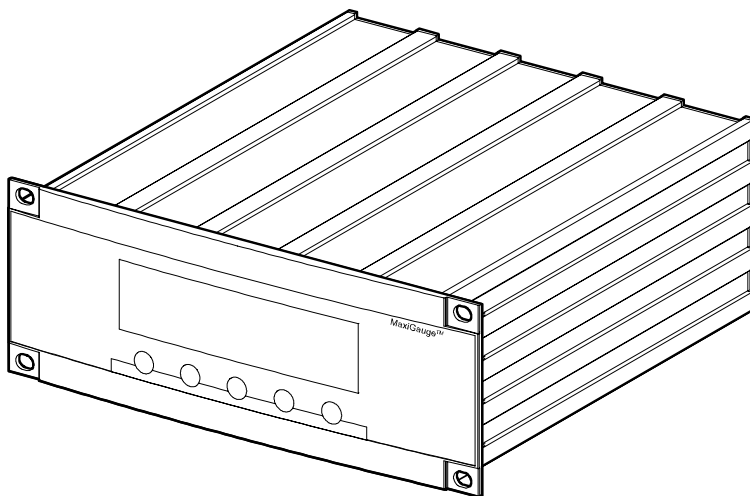

## Validity

This manual applies to products with part number:

- **PT G28 760** with serial interfaces RS232C and RS422
- **PT G28 761** with serial interfaces RS232C and RS422 and RS485 (addressable, isolated) and RS422 (isolated)

The part number can be taken from the nameplate on the rear panel, where the interfaces can be connected as well (→  12).

## Firmware Version

This manual is based on firmware version:

- **BG 509 730 -I**

If your unit does not behave as described in this document, please check whether it is equipped with this firmware version (→  109).

Enter the firmware version number of your unit in the space provided below:

- **BG** ..... - .....

## Trademarks

MaxiGauge™	INFICON GmbH
FullRange™	INFICON GmbH



We reserve the right to make engineering changes without notice.

## Contents

Validity	2
Firmware Version	2
Trademarks	2
<b>1 Intended Use</b>	<b>6</b>
<b>2 Technical Data</b>	<b>8</b>
<b>3 Safety</b>	<b>15</b>
<b>4 Commissioning</b>	<b>17</b>
4.1 Personnel	17
4.2 Set-Up, Assembly	17
4.3 Power Connection	18
4.4 Connecting the Gauges to <i>sensor</i>	21
4.5 <i>control</i> Control Connector	21
4.6 <i>RS 232/422</i> Pinout Connector for Serial Interfaces	23
4.7 <i>RS 485/422 isol.</i> Interface Port	23
4.8 <i>relay</i> Connector for Switch Contacts	23
<b>5 Operating Elements and Modes</b>	<b>24</b>
5.1 Operating Elements	24
5.2 Operating Modes (Overview)	27
5.2.1 «Measurement» Mode	28
5.2.2 «Setpoint» Mode	30
5.2.3 «General Parameter» Mode	31
5.2.4 «Sensor Parameter» Mode	32
5.2.5 «Sensor Control» Mode	33
5.2.6 «Test» Mode	34
<b>6 Display Formats and Pressure Units</b>	<b>35</b>
6.1 Display Formats	35
6.2 Pressure Units	36
6.3 Cursor	36
<b>7 Operation</b>	<b>37</b>
7.1 Personnel	37
7.2 Switching the Unit On and Off	37
7.3 Selecting the Operating Mode	39
7.4 «Measurement» Mode	40
7.4.1 Selecting the Measurement Point (Sensor)	40
7.4.2 Switching the Gauge On/Off (Sen-on/off)	41
7.4.3 Display of a Single Gauge / All Gauges (Single/All)	41
7.5 «Setpoint» Mode	42
7.5.1 Selecting the Switching Function (Relay)	42
7.5.2 Assigning Measurement Points (Control Sensor)	43
7.5.3 Defining the Threshold Values (Setpoint)	44
7.5.4 Underrange Control (UR-Control)	46

7.6	«General Parameter» Mode	48
7.6.1	Parameter Input Lock (Key-lock)	48
7.6.2	Selecting the Pressure Unit (Unit)	49
7.6.3	Display Resolution (Digits)	50
7.6.4	Bargraph (Bargraph)	51
7.6.5	Restoring Default Values (Default)	52
7.6.6	Defining an Interface (Interface)	53
7.6.7	Defining the Baud Rate (Baudrate)	54
7.6.8	Defining the Node Address (Address)	55
7.6.9	Screensave (Screensave)	56
7.6.10	Display Contrast (Contrast)	57
7.7	«Sensor Parameter» Mode	58
7.7.1	Selecting a Measurement Point (Sensor)	58
7.7.2	Gauge Identification (Type)	59
7.7.3	Offset Function (Offset) (zeroing)	60
7.7.4	Activating the Degas Routine (Degas)	63
7.7.5	Setting the Calibration Factor (Cal-Factor)	64
7.7.6	Setting the Measurement Value Filter (Filter)	65
7.7.7	Defining the Measurement Point Name (Name)	67
7.8	«Sensor Control» Mode	68
7.8.1	Selecting the Controlled Gauge (Sensor)	70
7.8.2	Selecting the Controlling Source (Control)	70
7.8.3	Setting the «Sensor 1 ... 6» Control	71
7.8.4	Setting the «Extern» Control	71
7.8.5	Setting the «Manual» Control	72
7.8.6	Setting the «Hotstart» Control	73
7.9	Status Messages	74
7.10	Error Messages	76
<b>8</b>	<b>Communication</b>	<b>79</b>
8.1	Serial Interfaces	79
8.1.1	Connection Diagrams	79
8.1.2	Connection Cable	80
8.1.3	Data Transmission	81
8.2	Mnemonics	85
8.2.1	Measurement Values	86
8.2.2	Display	89
8.2.3	Switching Functions	90
8.2.4	Parameters	91
8.2.5	Interfaces	94
8.2.6	Error Messages	97
8.2.7	Test Programs for Pfeiffer Vacuum Service Specialists	98

<b>9 Maintenance and Care</b>	<b>102</b>
9.1 Personnel	102
9.2 Cleaning	102
9.3 Maintenance	103
<b>10 Accessories and Spare Parts</b>	<b>104</b>
<b>11 Decommissioning</b>	<b>106</b>
<b>Appendix</b>	<b>107</b>
A: Validity Table	107
B: Conversion of Pressure Units	108
C: Equipment Test	108
D: Literature	112
<b>Declaration of Conformity</b>	<b>115</b>

For cross references to pages within this manual, the symbol (→  XY) is used, for references to other documents, the symbol (→  [Z]).

## 1 Intended Use

The MaxiGauge™ TPG 256 A is a 6-port total pressure measurement and control unit for Pfeiffer Vacuum Compact Gauges.

The unit has been engineered for use with the following gauge families \*):

- TPR Pirani gauge
- PCR Combined Pirani/Capacitance gauge
- IKR Cold cathode gauge
- PKR Combined Pirani/cold cathode gauge
- IMR Hot ionization gauge High Pressure (HP)
- PBR Combined Pirani/Bayard-Alpert hot cathode ionization gauge (BA)
- CMR/ACR Capacitive gauge
- APR Piezoresistive gauge

The unit is suited for total pressure measurement in the range of  $10^{-11}$  mbar to 50 bar ( $5 \times 10^4$  mbar). Through its pressure dependent switching functions and the user-programmable sensor control it can also perform a number of functions for controlling and monitoring vacuum equipment and processes.



### DANGER

Although this unit conforms to high quality and safety standards and has been built and tested in accordance with current technology, bodily injury and property damage cannot be precluded if it is used in non-conforming applications (for purposes other than intended) or if it is not used with diligence.

Therefore, it is essential that you carefully study this operating manual, especially the chapter "Safety". Keep this operating manual in a convenient location near your equipment.



### HINWEIS

\*) Comprehensive list of gauge types →  10.

Figure 1:  
Dimensions

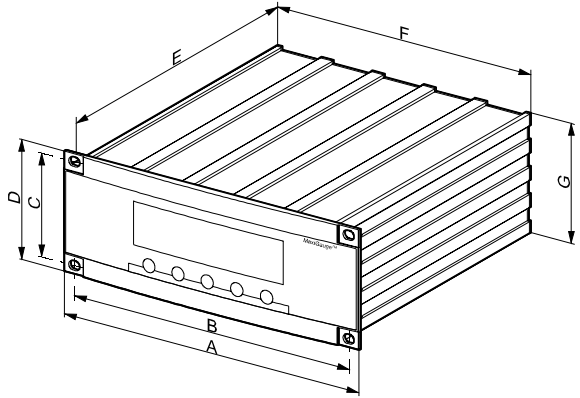

A	Width of front panel	241 mm (½ 19" rack width)
B	Mounting horizontal	224 mm
C	Mounting vertical	76.2 mm
D	Height of front panel	88 mm (2 height units)
E	Installed depth	228.5 mm
F	Installed width	207 mm
G	Installed height	88 mm (2 height units)

Figure 2:  
Nameplate

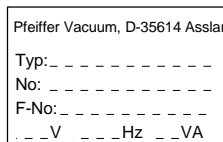

The nameplate is located on the rear panel.

Make sure that the voltage and frequency ratings conform with the local power supply system. The remaining information is important for communication with the Pfeiffer Vacuum customer service.

## 2 Technical Data



Mechanical data	Dimensions	→ Figure 1
	Weight	2.1 kg
	19" rack installation	→ Accessories,  104
Power connection	Voltage	90 ... 250 VAC / 50 ... 60 Hz
	Power consumption	60 VA
	Overvoltage category	II
	Protection class	1
	Unit connector	IEC 320 C14
	Power switch	Rear panel
Environment, standards	Temperatures	
	Storage	-20 ... +60 °C
	Operation	+ 5 ... +40 °C
	Relative humidity	Max. 80 % up to +31°C, decreasing to 50 % at +40 °C
	Use	Indoors only maximum height 2000 m
	Contamination severity	II
	Protection class	IP 30
	Safety  EMC	→  115

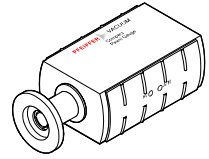

Figure 3:  
Gauges

**Logarithmic gauges**

**TPR**

Compact Pirani Gauge  
(Pirani gauge)



**PCR**

Compact Pirani Capacitance  
Gauge  
(Pirani/Capacitance gauge)

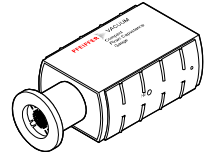

**IKR**

Compact Cold Cathode Gauge  
(Cold cathode gauge)

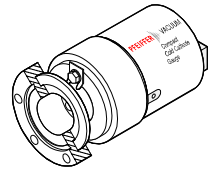

**PKR**

Compact FullRange™ CC Gauge  
(Pirani/Cold cathode gauge)

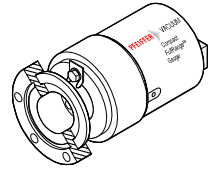

**IMR**

Compact Process Ion Gauge  
(Pirani/High pressure gauge)

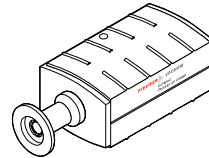

**PBR**

Compact FullRange™ BA Gauge  
(Pirani/Bayard-Alpert gauge)

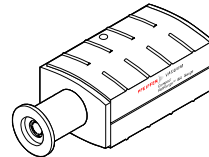

## Linear gauges

### CMR/ACR

Compact Capacitance Gauge  
(Capacitive gauge)

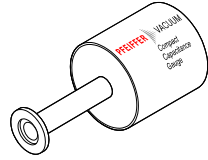

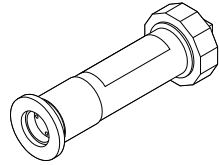

### APR

Compact Piezo Gauge  
(Piezoresistive gauge)



## Gauge connections

Number	6
Compatible gauges (→  [1] ... [15])	Pfeiffer Vacuum Compact Gauges
Compact Pirani Gauges	TPR 250, TPR 260, TPR 261, TPR 265, TPR 280, TPR 281
Compact Pirani Capacitance Gauge	PCR 260
Compact Cold Cathode Gauges	IKR 250, IKR 251, IKR 260, IKR 261, IKR 270
Compact FullRange™ CC Gauges	PKR 250, PKR 251, PKR 260, PKR 261
Compact Process Ion Gauges	IMR 260, IMR 265
Compact FullRange™ BA Gauges	PBR 260
Compact Capacitance Gauges	CMR 261, CMR 262, CMR 263, CMR 264, CMR 271, CMR 272, CMR 273, CMR 274, CMR 275; ACR 261, ACR 262, ACR 263, ACR 274
Compact Piezo Gauges	APR 250, APR 260, APR 262, APR 265, APR 266, APR 267
Connector type, pin assignments	→  20



### NOTE

With the exception of the IMR 265, PBR 260 and CMR 27X, which can only be connected to ports 4 to 6, any compatible gauge type can be connected to any analog output.



Measured values	Measurement ranges	→  Gauge
	Measurement error	
	Gain error	≤0.2 % measurement signal
	Offset error	≤20 mV
	Measurement rate	100 / s
Display rate	4 / s	
Filter time constant	slow	2.1 s (f <sub>g</sub> = 0.075 Hz)
	standard	320 ms (f <sub>g</sub> = 0.5 Hz)
	fast	100 ms (f <sub>g</sub> = 1.6 Hz)
Gauge supply	Voltage	+24 VDC ± 5%
	Current	
	Sensor 1 to 3	200 mA per gauge
	Sensor 4 to 6	600 mA per gauge
	Fuse	
Sensor 1 to 3	300 mA per gauge	
Sensor 4 to 6	1 A per gauge (PTC element, self resetting after unit is switched off)	
Gauge control	Turning the gauge on / off	
	Manual	Softkey (Sen-on / Sen-off)
	Automatic	by gauge 1 ... 6 (Sensor X) (IKR, IMR by TPR, PKR, etc.) adjustable setpoints, user-assignable
	Hot Start	IKR, PKR, IMR and PBR gauges are turned on when the unit is switched on
	External	Individually for each gauge at the «Control» connector TTL high: +2 ... 5 V = gauge off TTL low: ≤+0.8 V = gauge on Internal pull-up 3.3 kΩ to +5 V
	Self-monitoring	IKR and IMR gauge turned off by own measured value
Degas	Degas (PBR 260 only)	Duration 3 min. (can be aborted)

Figure 4:  
Rear panel

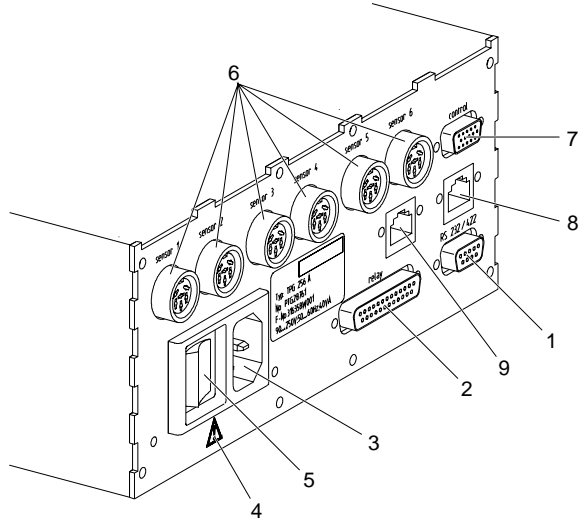

MaxiGauge™ part number PT G28 760:

1	<i>RS 232/422</i>	Pinout for serial interface RS232C or RS422 (not isolated)
2	<i>relay</i>	Connector for relay switch contacts
3		Power inlet 3-pin
4		Reference for fuses inside the unit (replacement only by Pfeiffer Vacuum Service)
5		Power switch
6	<i>sensor 1 ... ... sensor 6</i>	Connectors for gauges
7	<i>control</i>	Connector for control functions

MaxiGauge™ part number PT G28 761, additional features:

8,9	<i>RS 485/422 isol.</i>	Port for serial interface RS485 (addressable, isolated) and RS422 (isolated)
-----	-------------------------	--

Connector types and pin assignments →  20 f.









Switching functions	Number	6
	Gauge assignment	User-programmable
	Response time	10 ms, if the measured value is near the setpoint. For bigger differences, take the filter time constant into consideration.
	Relay contacts	Changeover switch, floating $U_{\max} = 60 \text{ VDC} / I_{\max} = 3 \text{ A}$ $U_{\max} = 30 \text{ VAC} / I_{\max} = 3 \text{ A}$
	Contact closed	Vacuum better than setpoint
	Contact open	Vacuum worse than setpoint or power switched off
	Cycle life mechanical electrical	$5 \times 10^7$ cycles $1 \times 10^5$ cycles
Connector type, pin assignment	→  22	
Error signal	Response time	10 ms
	Relay contact	Changeover switch, floating $U_{\max} = 60 \text{ VDC} / I_{\max} = 3 \text{ A}$ $U_{\max} = 30 \text{ VAC} / I_{\max} = 3 \text{ A}$
	Contact closed	No error
	Contact open	Error or mains power switched off
	Cycle life mechanical electrical	$5 \times 10^7$ cycles $1 \times 10^5$ cycles
	Connector type, pin assignment	→  22
	Analog outputs	Number
Voltage range		0 ... +10 V
Internal resistance		660 $\Omega$
Relationship measurement signal-pressure		→  Gauge used
Connector type, pin assignment		→  20
Computer interfaces		Standard
	Option (for PT G28 760)	RS485, addressable, isolated RS422, isolated
	Protocol	ACK/NAK, ASCII with 3 character mnemonics, bi-directional data flow (master-slave) (additional information →  79)
	RS232C	Only TXD and RXD used
	RS422, RS485	Only TX+, TX-, RX+, RX- used
	Connector type, pin assignment	→  22

Figure 5:  
Symbols for residual hazards

	<b>DANGER</b>
	Information on preventing any kind of bodily injury or extensive property damage.

	<b>CAUTION</b>
	Special information on damage prevention.



	<b>NOTE</b>
	Special information on cost-effective use.

Figure 6:  
Symbol for special personal qualifications

	<b>Specialists</b>
	This work may only be carried out by persons with suitable technical training and the necessary experience.

## 3 Safety

### 3.1 Personnel



#### Specialists

Work on and with the MaxiGauge™ TPG 256 A may only be carried out by persons with suitable technical training and the necessary experience.

### 3.2 Danger, Caution, and Note Symbols

The opposite symbols together with explanatory text are used to point out residual dangers inherent in conforming utilization and to emphasize important technical requirements.

### 3.3 Safety Information

- Take into account the relevant safety regulations when doing installing and maintenance work.

### 3.4 Responsibility and Warranty

Pfeiffer Vacuum declines any liability, and the warranty becomes null and void if the operator or third parties

- utilize the product not according to the defined use
- disregard the technical data
- make any kind of changes (modifications, alterations, etc.) to the product
- use the product with accessories not listed in the product documentation.

Figure 7:  
Setup as desktop unit

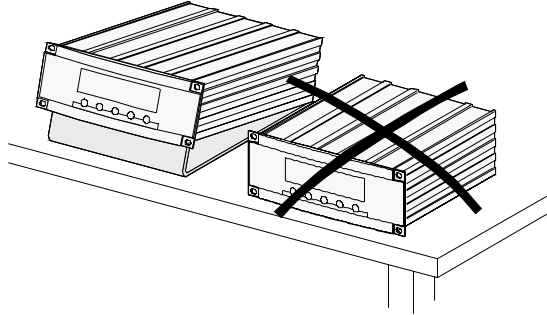

Make sure to provide for proper ventilation when using the MaxiGauge™ as desktop unit. For this purpose, an acrylic glass stand can be ordered as accessory (→ Accessories  104).

Figure 8:  
Connection cable



Use a connection cable with ground conductor.

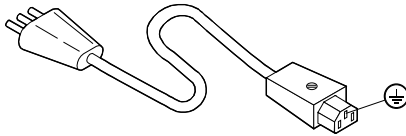

**CAUTION**

If you can assume, for example for one of the following reasons, that the unit is no longer safe to operate, shut it down and secure it so that it cannot be inadvertently turned on again:

- a) the unit has sustained visible damage
- b) it no longer functions
- c) it has been stored for a longer period under unfavorable conditions
- d) it has been subjected to severe transport stress



**DANGER**

Any interruption of the protective ground inside or outside the unit, or disconnection of the protective ground makes the equipment hazardous to operate (electric shock).



## 4 Commissioning

### 4.1 Personnel



#### Specialists

The unit may be put into service by skilled and suitably trained persons only.

### 4.2 Set-Up, Assembly

There are two possibilities for incorporating the unit into a switching cabinet according to DIN 41 494:

- Installation in a 19" rack frame (2 height units) together with a second unit or with a blanking plate (→ Accessories 104)
- Installation in a 19" rack frame using an adapter (3 height units, ¾ rack width) (→ Accessories 104)

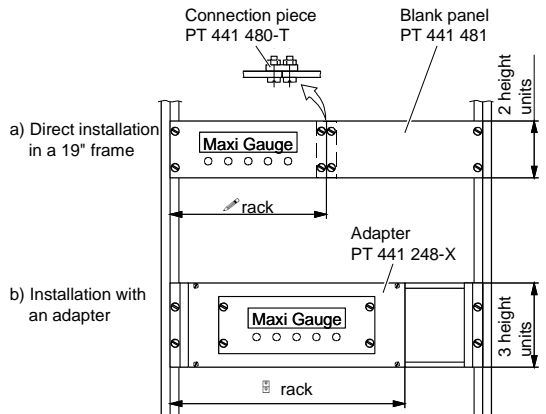

With an acrylic glass stand (→ Accessories 105), it can also be used as bench top unit.



#### CAUTION

Consider the specifications in the "Technical data" with regard to the admissible ambient temperature, the protection class and the voltages.

### 4.3 Power Connection

Before switching the unit on make sure that the operating voltage of the unit corresponds to the local line voltage. The power ratings are indicated on the product nameplate on the rear panel of the unit.

Use only a 3-conductor power cable with protective ground. The power connector may only be plugged into a socket with a protective ground. This protection must not be defeated by an extension cable without ground conductor.

If the unit is to be installed in a rack, the power must be supplied via a switched power distributor.

**Notes:**

Figure 9:  
Gauge connector *sensor*

Pin assignment

- 1 Identification
- 2 GND
- 3 Measurement signal +
- 4 Measurement signal -
- 5 Screen
- 6 Vcc

Amphenol C91B,  
6-pin, female

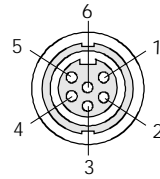

Front view

Figure 10:  
Control connector *control*

Pin assignment

- 1 Analog output sensor 1
- 2 Analog output sensor 2
- 3 Analog output sensor 3
- 4 Analog output sensor 4
- 5 Analog output sensor 5
- 6 Analog output sensor 6
- 7 GND
- 8 GND
- 9 GND
- 10 External control sensor 1
- 11 External control sensor 2
- 12 External control sensor 3
- 13 External control sensor 4
- 14 External control sensor 5
- 15 External control sensor 6

D-Sub, high density,  
15-pin, female

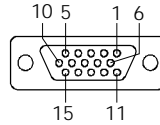

Front view

#### 4.4 Connecting the Gauges to *sensor*

**NOTE**

Switch the unit off before connecting or removing any gauges.

Connect the gauge to one of the six connectors *sensor 1* ... *sensor 6* (PBR 260, IMR 265 and CMR 27X only to *sensor 4* ... *sensor 6*) on the rear panel of the unit by means of a shielded cable (electromagnetic compatibility). Connect only gauge types specified in the "Technical data".

Pre-fabricated connection cables as well as individual parts for custom cable fabrication are available (→ Accessories  104).

#### 4.5 *control* Control Connector

Configure the control connector as required. Plug it into the *control* socket on the rear panel.

**NOTE**

Use only shielded cables (electromagnetic compatibility).

Figure 11:  
RS 232/422  
Pinout connector for serial  
interfaces

- Pin assignment
- 1 Chassis
  - 2 RXD (RS232C)
  - 3 TXD (RS232C)
  - 4 not connected
  - 5 Signal Ground
  - 6 RX+ (RS422)
  - 7 RX- (RS422)
  - 8 TX+ (RS422)
  - 9 TX- (RS422)

D-Sub, 9-pin, male

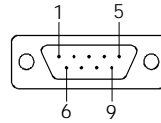

Front view

Figure: 12  
RS 485/422 isol.  
Serial interface port

- Pin assignment
- 1 TX+
  - 2 TX-
  - 3 RX+
  - 4 not connected
  - 5 not connected
  - 6 RX-
  - 7 not connected
  - 8 Isolation ground

RJ45, 8-pin

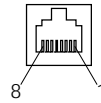

Front view

Figure 13:  
relay  
Connector for switch contacts

- Pin assignment
- 6 —————
  - 5 ————— Relay A
  - 4 —————
  - 10 —————
  - 9 ————— Relay B
  - 8 —————
  - 13 —————
  - 12 ————— Relay C
  - 11 —————
  - 18 —————
  - 17 ————— Relay D
  - 16 —————
  - 21 —————
  - 20 ————— Relay E
  - 19 —————
  - 24 —————
  - 23 ————— Relay F
  - 22 —————
  - 14 —————
  - 15 ————— Error Relay
  - 3 —————
  - 25 — + 24 V max. 200 mA
  - 1,7 — GND (Chassis)

D-Sub, 25-pin,  
female

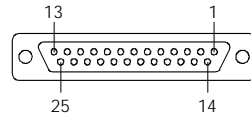

Front view

#### 4.6 **RS 232/422 Pinout Connector for Serial Interfaces**

Connect the serial interface to the *RS 232/422* pinout connector on the back of the unit by means of a shielded cable (electromagnetic compatibility).

#### 4.7 **RS 485/422 isol. Interface Port**

Connect the serial interface to the *RS 485/422 isol.* port on the back of the unit by means of a shielded cable (electromagnetic compatibility).

The two connectors are linked 1:1. This allows for easy integration of the MaxiGauge™ into a network.

#### 4.8 **relay Connector for Switch Contacts**

Connect the peripheral components to the *relay* connector on the back of the unit by means of a shielded cable (electromagnetic compatibility).



#### **CAUTION**

Only low voltages (→  13) may be connected. Higher voltages can damage equipment components.

A relay interface with changeover contacts for 250 V / 5 A is available as accessory (→  104).

## 5 Operating Elements and Modes

### 5.1 Operating Elements

#### Softkeys

The MaxiGauge™ is operated with the five softkeys on the front panel (→ figure 14). The functions of these softkeys vary depending on the operating mode the unit is in. The current function is indicated by the LCD graphic display.

#### Power switch

The mains power switch is located on the back of the unit (→ figure 15). When the unit is on, the mains power indicator (green LED) on the front panel is lit (→ figure 14).



#### NOTE

When (Screensave) is activated, it may seem that the unit is switched off (→  56).



Figure 14:  
Front panel

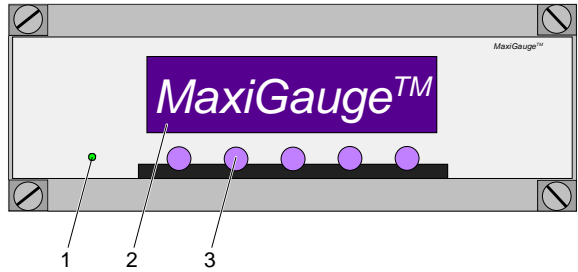

- 1 Mains power indicator (green LED): on / off
- 2 Display (LCD): Measured values and operation data
- 3 5 Softkeys (operating keys with varying functions)

Figure 15:  
Power switch

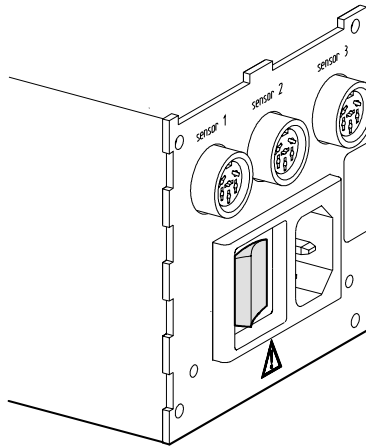
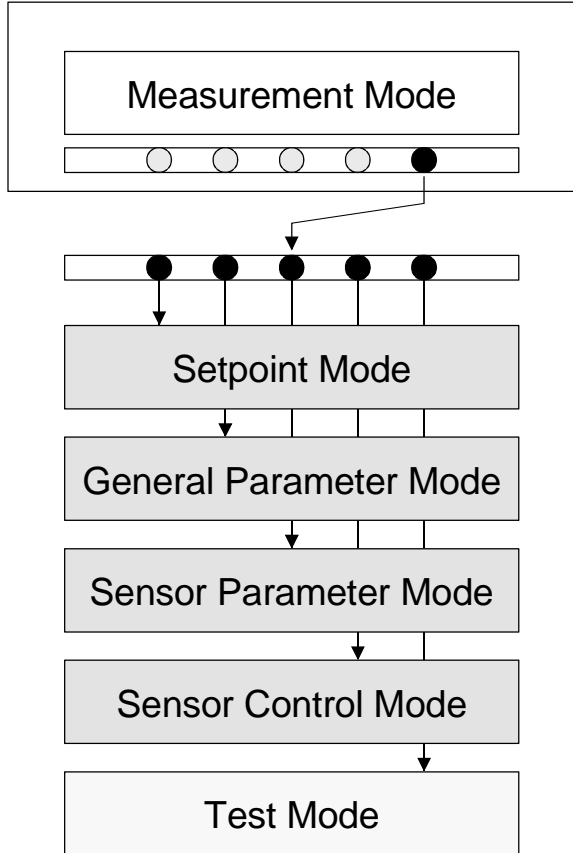







Figure 16:  
Operating modes



## 5.2 Operating Modes (Overview)







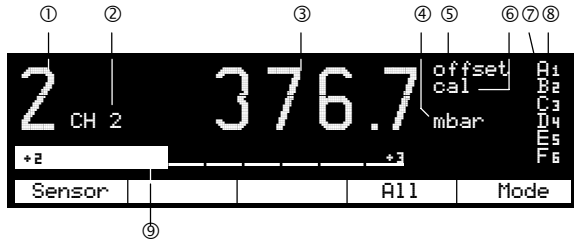

- «Measurement» In «Measurement» mode, the MaxiGauge™ displays either the measured value of one single gauge at a time in big characters or the measured values of all gauges simultaneously in small characters (→  28, 40).
- «Setpoint» In «Setpoint» mode, a you can assign a switching function to a measurement point and define the corresponding setpoints (→  30, 42).
- «General Parameter» In «General Parameter» mode, you can define the system parameters (for all connected gauges together) (→  31, 48).
- «Sensor Parameter» In «Sensor Parameter» mode, you can define the relevant parameters for each gauge (→  32, 58).
- «Sensor Control» In «Sensor Control» mode, you can define how an individual gauge is switched on / off (→  33, 68).
- «Test» The «Test» mode is used for diagnostic and service purposes (troubleshooting). Special knowledge and skills are necessary for this work (→  34, 108).

## 5.2.1 «Measurement» Mode

Figure 17:  
«Single» display



### Display

①	Measurement point selected (from 1 ... 6)
②	Name of measurement point, 4 characters, user-definable (→  67)
③	Measured value or status (→  35)
④	Unit of measurement (→  49)
⑤	Offset correction activated (→  60)
⑥	Calibration factor ≠ 1.00 (→  64)
⑦	Designation of the switching function (A ... F) (→  42)
⑧	Controlling source (from 1 ... 6) (→  43)
⑨	Bargraph (analog measured value) (→  51)

### Softkeys

Sensor	Selection of measurement point
Sen-on *)	Turning the gauge on
Sen-off *)	Turning the gauge off
All	Displaying the measured values of all measurement points
Mode	Activating the operating mode selection









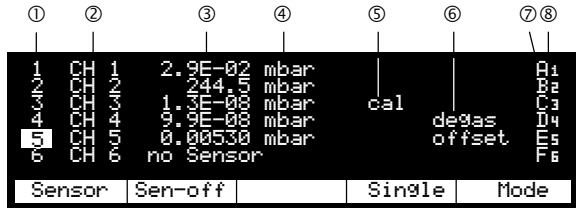

 **NOTE**  
\*) This parameter is not available for all gauge types (→ Validity table  107).

Figure 18:  
«All» display





Display

①	All measurement points (1 ... 6) The selected measurement point is represented inversely
②	Name of measurement point, 4 characters, user-definable (→  67)
③	Measured values or status (→  35)
④	Unit of measurement (→  49)
⑤	Calibration factor ≠ 1.00 (→  64)
⑥	Sensor 4: Degas activated (→  63) Sensor 5: Offset correction activated (→  60)
⑦	Designation of the switching function (A ... F) (→  42)
⑧	Controlling source (from 1 ... 6) (→  43)

Softkeys

Sensor	Selection of measurement point
Sen-on *)	Turning the gauge on
Sen-off *)	Turning the gauge off
Single	Displaying the measured value of an individual measurement point
Mode	Activating the operating mode selection



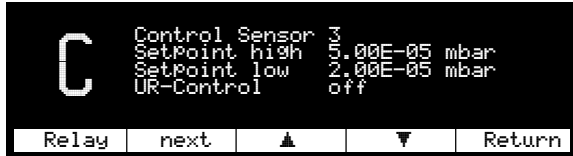

 **NOTE**  
\*) This parameter is not available for all gauge types (→ Validity table  107).

## 5.2.2 «Setpoint» Mode



Figure 19:  
«Setpoint» display



Display

C	Switching function selected (from A ... F)
Control Sensor	Controlling source (1 ... 6) of switching function C (→  43)
SetPoint high	Upper threshold of switching function C (→  44)
SetPoint low	Lower threshold of switching function C (→  44)
UR-Control *)	Behavior of switching function C in case of underrange (→  46)

Softkeys

Relay	Selection of switching function (from A ... F)
next	Parameter selection
	Increasing the value
	Decreasing the value
Return	Returning to the «Measurement» mode

 **NOTE**  
\*) This parameter is not available for all gauge types (→ Validity table  107).

### 5.2.3 «General Parameter» Mode

Figure 20:  
«General Parameter» display

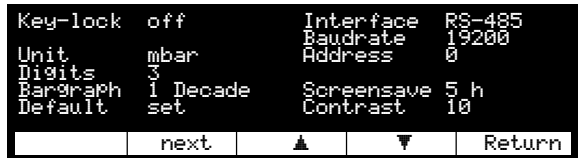

Display

Key-lock	Parameter input lock enabled or disabled (→ 48)
Unit *)	Pressure unit (→ 49)
Digits	Resolution of the measured value display (logarithmic gauges only) (→ 50)
Bargraph	Bargraph (→ 51)
Default	Loading the standard values of the parameters (→ 52)
Interface	Type of the serial interface (→ 53)
Baudrate	Baud rate of the interface (→ 54)
Address **)	Software address of the interface (→ 55)
Screensave	Screensave (→ 56)
Contrast	Contrast of the display (→ 57)

Softkeys

next	Parameter selection
▲	Increasing the value
▼	Decreasing the value
Return	Returning to the «Measurement» mode

 **NOTE**

\*) The pressure units depend on the gauges used (→ Validity table 36).







\*\*) This parameter is available for the RS485 interface only.

### 5.2.4 «Sensor Parameter» Mode



Figure 21:  
«Sensor Parameter» display



Display

2	Measurement point selected (from 1 ... 6)
Type *)	Family of gauge **) connected / type of gauge connected (→  59)
Offset ***) or Degas ***)	Activation of offset correction (→  60) Activation of degas (→  63)
Cal-Factor	Calibration factor selected for measurement point 2 (→  64)
Filter	Measured value filter selected for measurement point 2 (→  65)
Name	User-definable name for measurement point (up to 4 characters) (→  67)

Softkeys

Sensor	Selection of measurement point
next	Parameter selection
	Increasing the value
	Decreasing the value
Return	Returning to the «Measurement» mode

 **NOTE**

\*) Depending on the type of gauge identified, the measurement range may need to be indicated.

\*\*) The family of linear including ACR gauges are displayed with APR/CMR.

\*\*\*) This parameter is not available for all gauge types (→ Validity table  107).



## 5.2.5 «Sensor Control» Mode

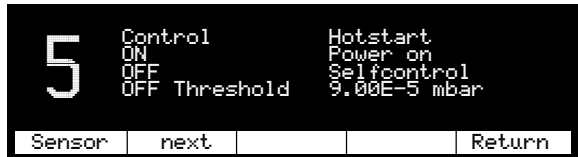

Figure 22:  
«Sensor Control» display





Display

5	Measurement point selected (from 1 ... 6)
Control *	Controlling source of measurement point 5 (→  70)
ON	Measurement point 5 is activated when the unit is switched on
OFF Selfcontrol	Switching-off mode of measurement point 5
OFF Threshold	Switching-off threshold of measurement point 5 in self-monitoring mode

Softkeys

Sensor	Selection of measurement point
next	Parameter selection
	Increasing the value
	Decreasing the value
Return	Returning to the «Measurement» mode

 **NOTE**

\*) This parameter is not available for all gauge types (→ Validity table  107).

## 5.2.6 «Test» Mode

Figure 23:  
«Test» display

```

Program BG509730-I
RAM                A/D
EPROM             I/O
EEPROM           Interface
Display          WDT-Ctrl  auto
  
```

	next		Start	Return
--	------	--	-------	--------

Display

Program	Firmware version (→ 108)	
RAM	RAM self-test	(→ 109)
EPROM	EPROM self-test	(→ 109)
EEPROM	EEPROM self-test	(→ 109)
Display	Display self-test	(→ 110)
A/D	Test analog/digital converter	(→ 110)
I/O	Relay test	(→ 110)
Interface	Test serial interface	(→ 111)
WDT-Ctrl	Watchdog control	(→ 111)

Softkeys

next	Parameter selection
Start	Starting a test sequence
Return	Returning to the «Measurement» mode

**NOTE**

The «Test» mode is only available if a key was pressed while the unit was switched on.

## 6 Display Formats and Pressure Units

### 6.1 Display Formats

Both, exponential and floating point formats are used. The format is changed over automatically. Pressures indicated in «Pa» are displayed in exponential format only.

Figure 24:  
Exponential representation



Figure 25:  
Display formats

	Logarithmic gauges	Linear gauges
50 bar		
1000 mbar	Floating point format	Floating point format
1 mbar (or 1 Torr)	e.g. 4.3	e.g. 4.3
10 <sup>-11</sup> mbar	Exponential format e.g. 4.16E-01	

## 6.2 Pressure Units

Whether a particular pressure unit can be displayed or not depends on the gauge used. The MaxiGauge™ allows the selection of a specific pressure unit only if it is possible to display the pressure in that unit over the whole measurement range.

Gauge	Range*)	mbar/bar	Torr	Pa
Logarithmic	10 <sup>-11</sup> mbar	✓	✓	✓
	... 1000 mbar			
Linear	0.1 mbar	✓	✓	✓
	1 mbar	✓	✓	✓
	10 mbar	✓	✓	✓
	100 mbar	✓	✓	
	1000 mbar	✓	✓	
	2 bar	✓	✓	
	5 bar	✓	✓	
	10 bar	✓		
50 bar	✓			

Conversion of pressure units (→  108)

\*) Full scale value for linear gauges

## 6.3 Cursor

The cursor points out a selected parameter (value), a gauge or a switching function status «on» by representing it inversely.

Figure 26:  
Cursor (inverse representation of parameter value)

```

Key-lock  off          Interface  RS-485
Unit      mbar         Baudrate  19200
Digits    3             Address    0
BarGraph  1 Decade      Screensave 5 h
Default   set           Contrast  10
  
```

	next			Return
--	------	---	---	--------

Figure 27:  
Cursor (inverse representation of gauge / switching function)

```

1 CH 1 2.9E-02 mbar      A1
2 CH 1 4.16E-01 mbar      B2
3 CH 1 1.3E-08 mbar      cal  C3
4 CH 1 9.9E-11 mbar      D4
5 CH 1 0.0053 mbar      offset E5
6 CH 6 no Sensor        F6
  
```

Sensor	Sen-off		Single	Mode
--------	---------	--	--------	------

## 7 Operation

### 7.1 Personnel



#### Specialists

The unit may only be operated by skilled and trained persons that fully understand the possible hazards related to the corresponding application.

### 7.2 Switching the Unit On and Off

#### Power ON

Check that all cables and gauges have been correctly installed and that the specifications listed in the technical data have been met.

Turn the unit on with the power switch (or centrally via a switched power distributor if the unit is rack mounted). The power switch is located on the rear panel of the unit.

Figure 28:  
Power switch

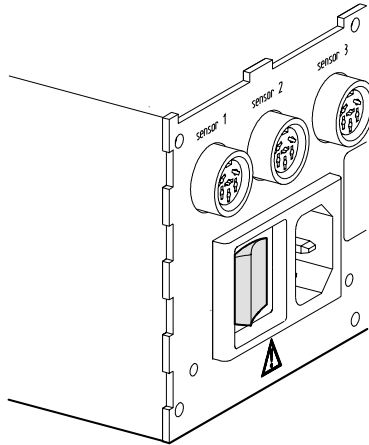

After power ON, the unit:

- automatically performs a self-test, and «MaxiGauge™» is displayed
- identifies the gauges connected
- activates parameters that were in effect before the last power OFF
- switches to the «Measurement» mode for the measurement point selected before the last power OFF
- adapts the parameters if required (if other gauges were previously connected)

Figure 29:  
Display after power ON



Power OFF

- Turn the unit off with the power switch (or centrally via a switched distributor if the unit is rack mounted).



**NOTE**

Wait at least 10 seconds before turning the unit on again in order for it to correctly initialize itself.

### 7.3 Selecting the Operating Mode

In the superset «Measurement» mode, you can call a menu of further operating modes by pressing the [Mode] softkey

Select the desired mode by pressing the corresponding softkey:

- [Setpoint] «Setpoint» mode
- [Gen-Par] «General Parameter» mode
- [Sen-Par] «Sensor Parameter» mode
- [Sen-Ctrl] «Sensor Control» mode

Figure 30:  
Selecting the operating mode



The «Test» mode can only be selected if a key was pressed while the unit was switched on:

- [Test] «Test» mode

Returning from other operating modes

If you are in a lower mode, simply press the [Return] softkey to return to the superset «Measurement» mode. If you do not press any key for 1 minute, the display returns automatically to the «Measurement» mode.

## 7.4 «Measurement» Mode

In the superset «Measurement» mode, the unit displays the measured values. If you are in another (lower) mode and do not press any key for 1 minute, the unit returns automatically to the «Measurement» mode.

(→ Overview «Measurement» mode  28).

Figure 31:  
«Single» display



Figure 32:  
«All» display

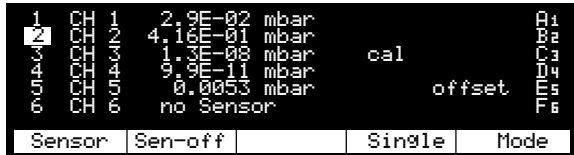

### 7.4.1 Selecting the Measurement Point (Sensor)

- The measurement point is indicated as a number on the left of the display.
- Select the next measurement point with the [Sensor] softkey (in «Single» measurement mode, the corresponding number is increased whereas in «All», the selected measurement point is represented inversely). After the measurement point 6 the display changes to measurement point 1.



### 7.4.2 Switching the Gauge On/Off (~~Sen-on/off~~)

- Press the [~~Sen-off~~] softkey to turn the selected gauge off or the [~~Sen-on~~] key to turn it on.



#### CAUTION

Turning a gauge on or off may affect the status of the relays.



#### NOTE



This parameter is not available for all gauge types (→ Validity table  107).

### 7.4.3 Display of a Single Gauge / All Gauges (~~Single/All~~)

- Press the [~~Single/All~~] softkey in order for the unit to display either the measured value of one single gauge at a time or the measured values of all gauges simultaneously (→  40).



#### NOTE

Status or error messages may be displayed instead of measured values (→ Status messages  74, Error messages  76). After the problem is remedied, the measured value is again displayed correctly.

## 7.5 «Setpoint» Mode

In «Setpoint» mode, you can assign a controlling source to a switching function and define the upper and lower thresholds. Additionally, you can select the behavior of the switching function in the event of an underrange.

(→ Overview «Setpoint» mode  30).

Figure 33:  
«Setpoint» display

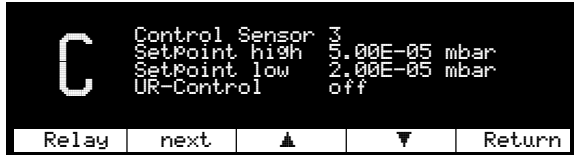

### 7.5.1 Selecting the Switching Function (Relay)

The switching function is represented as a letter on the left of the display.

Selecting another switching function:

- Press the [Relay] softkey to choose the desired switching function (H ... F).

The modifications are automatically stored in non-volatile memory.

### 7.5.2 Assigning Measurement Points (Control Sensor)

The upper parameter line «Control Sensor» shows which measurement point is assigned to a switching function.

The corresponding measurement point has to be assigned to each switching function individually. In «Measurement» mode, all assignments are displayed simultaneously.

Figure 34:  
«Setpoint» display

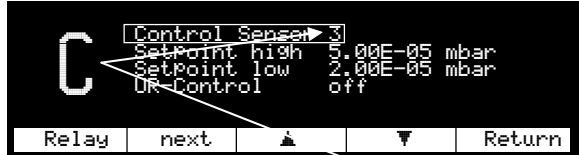

«Measurement» display



Assigning another measurement point:

- Select the «Setpoint» mode (if applicable) (→ 39)
- Press the [next] softkey to select the «Control Sensor» parameter
- Press the [▲] or [▼] softkey to select a parameter value «1 ... 6» (measurement points)
- Press the [Return] softkey to return to the «Measurement» mode



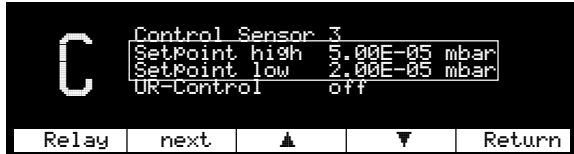

The modifications are automatically stored in non-volatile memory.

### 7.5.3 Defining the Threshold Values (SetPoint)

Figure 35: «Setpoint» display



Defining the threshold values:

- Select the «Setpoint» mode (if applicable) (→  39)
- Press the [next] softkey to select the «Setpoint high» parameter
- Press the [] or [] softkey to increase /decrease the upper threshold value
- Press the [next] softkey to select the «Setpoint low» parameter
- Press the [] or [] softkey to increase / decrease the lower threshold value
- Press the [Return] softkey to return to the «Measurement» mode

 **NOTE**

A threshold that is outside the measuring range is adjusted in such a way that it corresponds to the lower (upper) range limit.

If both thresholds are outside the measuring range, they are adjusted analogously in such a way that a minimum hysteresis is achieved.

 **NOTE**

For logarithmic gauges, threshold values are displayed in logarithmic or floating point format, whereas for linear gauges, they are displayed in floating point format only (→ Display formats  35).

The modifications are automatically stored in non-volatile memory.

Figure 36:  
Threshold values of a switching function

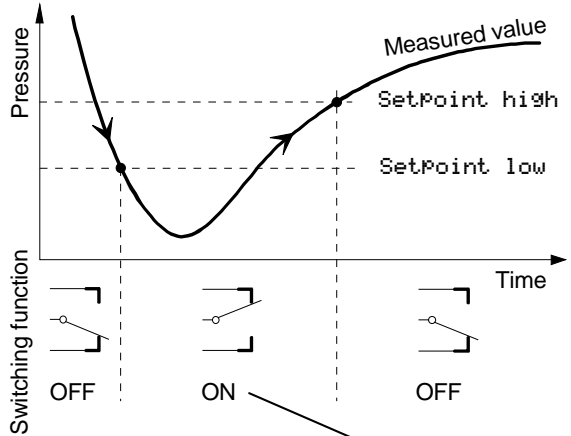
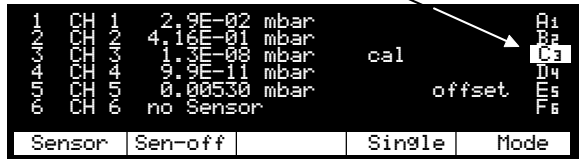

Figure 37:  
Inverse representation of the selected switching function (C3)



setPoint low  
setPoint high

The `setPoint low` defines the pressure reading at which the switching function is activated when the pressure is dropping.

The `setPoint high` defines the pressure reading at which the switching function is deactivated when the pressure is rising.

**NOTE**

If other gauge types were connected previously, the threshold may possibly have been adapted automatically.

**NOTE**

Logarithmic gauges:

The minimum hysteresis between the upper and lower threshold is at least 10% of the lower threshold. This prevents an unstable state. If you set the upper threshold lower than the lower one, this minimum hysteresis is automatically applied.

Linear gauges:

The minimum hysteresis between the upper and lower threshold is at least 1% of the measurement range. This prevents an unstable state. If you set the upper threshold lower than the lower threshold, this minimum hysteresis is automatically applied.

#### 7.5.4 Underrange Control (UR-Control)

This parameter controls the behavior of the switching function in the event of an underrange (→ Status messages  74).

An underrange may occur for one of the following reasons:

- The pressure in the vacuum system is lower than the lower limit of the measurement range
- The gauge has not yet ignited
- The discharge has failed
- A fault has occurred

When the underrange control is enabled, an underrange is interpreted as inadmissible measured value: The switching function changes to «OFF».

When the underrange control is deactivated, the switching function remains «ON» in the event of an underrange.

The underrange control is deactivated by default.

Figure 38:  
«Setpoint» mode display

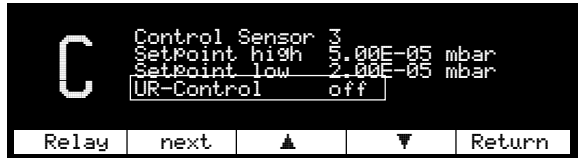

Enabling/disabling the underrange control:

- Select the «Setpoint» mode (if applicable) (→ 39)
- Press the [next] softkey to select the «UR-Control» parameter
- Press the [▲] or [▼] softkey to select «On» (underrange control enabled) or «Off» (underrange control disabled (default))
- Press the [Return] softkey to return to the «Measurement» mode



#### NOTE

This parameter is not available for all gauge types (→ Validity table 107).



#### NOTE

If the pressure in the vacuum chamber may be lower than the lower limit of the measurement range of the gauge it may be advantageous to select «off».



#### NOTE

When «On» is selected, the switching function evaluation is suppressed for approx. 10 seconds after the gauge has been turned on or an underrange has occurred. The switching function remains «OFF» for this time.

The modifications are automatically stored in non-volatile memory.

## 7.6 «General Parameter» Mode

In «General Parameter» mode, you can define the system parameters for all connected gauges together.  
 (→ Overview «General Parameter» mode  31).

Figure 39:  
 «General Parameter» display



### 7.6.1 Parameter Input Lock (Key-lock)

The parameter input lock prevents inadvertent entries and consequent malfunctions. When the parameter input lock is enabled, only the «Key-Lock» parameter for disabling the input lock can be modified.

Turning the parameter input lock ON /OFF:

- Select the «General Parameter» mode (if applicable)  
 (→  39)
- Press the [next] softkey to select the «Key-lock» parameter
- Press the [▲] or [▼] softkey to select «On» (input lock ON) or «Off» (input lock OFF(default))
- Press the [Return] softkey to return to the «Measurement» mode

 **NOTE**

If the input lock is enabled and you press a softkey to modify any other parameter than «Key-lock», «locked» is displayed instead of the function of the softkey pressed.

The modifications are automatically stored in non-volatile memory.



## 7.6.2 Selecting the Pressure Unit (Unit)

Figure 40:  
«General Parameter» display

The unit can display the following pressure units:  
(milli)bar, Torr, and Pascal.

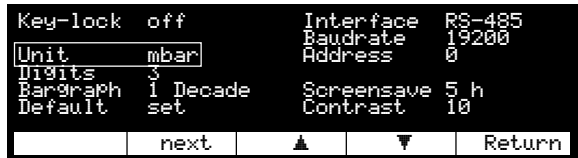

Selecting the pressure unit:

- Select the «General Parameter» mode (if applicable) (→  39)
- Press the [next] softkey to select the «Unit.» parameter
- Press the [▲] or [▼] softkey to select «Torr», «Pa», or «mbar» (default)\*)
- Press the [Return] softkey to return to the «Measurement» mode

The modifications are automatically stored in non-volatile memory.



### NOTE

\*) For linear gauges, a specific pressure unit can only be selected if it is possible to display the measured pressure in that unit over the whole measurement range of the gauge (→ table  36).

### 7.6.3 Display Resolution (Digits)

For observing even fine measurement value fluctuations, the display can be increased from 2 to 3 digits. The measured value will thus have a finer resolution. (Only effective for logarithmic gauges.)

Figure 41:  
«General Parameter» display



Defining the number of digits:

- Select the «General Parameter» mode (if applicable) (→  39)
- Press the [next] softkey to select the «Digits» parameter
- Press the [▲] or [▼] softkey to select «3» or «2» (default)
- Press the [Return] softkey to return to the «Measurement» mode

The modifications are automatically stored in non-volatile memory.

## 7.6.4 Bargraph (Bargraph)

The bargraph allows quick assessment of the measured value and visual observation of the measurement changes (trend).

Figure 42:  
«General Parameter» display

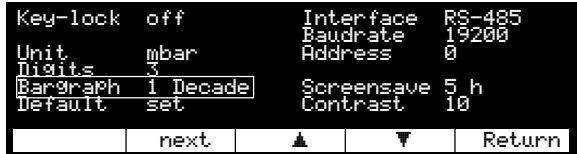

Adjusting the bargraph:

- Select the «General Parameter» mode (if applicable) (→ 39)
- Press the [next] softkey to select the «Bargraph» parameter
- Press the [▲] or [▼] softkey to select «Off» (bargraph deactivated), «Sen-Range» (bar range = measurement range), or «1 Decade» (bar = measurement value exponent (default))
- Press the [Return] softkey to return to the «Measurement» mode

The modifications are automatically stored in non-volatile memory.

### 7.6.5 Restoring Default Values (Default)



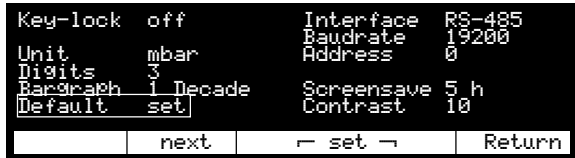

This parameter allows to restore all user defined / modified parameters to the factory setting.

Figure 43:  
«General Parameter» display



Restoring the default parameters:

- Select the «General Parameter» mode (if applicable) (→  39)
- Press the [next] to select the «Default set.» parameter

The [] and [] softkeys are represented as one single symbol prompting the user to press them simultaneously: [ set ].

- Press both softkeys simultaneously to restore the default values
- Press the [Return] softkey to return to the «Measurement» mode

	<b>CAUTION</b>
	Restoring the default values cannot be reversed!

The modifications are automatically stored in non-volatile memory.

### 7.6.6 Defining an Interface (Interface)





The serial interfaces are used for external control of the unit as well as for transfer of measured data and modification of parameters (→  13). The desired interface is defined with the following parameter:

Figure 44: «General Parameter» display

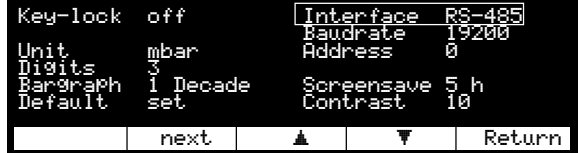

Defining the interface:

- Select the «General Parameter» mode (if applicable) (→  39)
- Press the [next] softkey to select the «Interface» parameter
- Press the [] or [] softkey to select among «RS-485» (serial interface RS485, isolated), «RS-422I» (serial interface RS422C, isolated), «RS-422» (serial interface RS422C, not isolated), «RS-232» (serial interface RS232C, not isolated (default))
- Press the [Return] softkey to return to the «Measurement» mode



**NOTE**

Check whether the unit is equipped with all interfaces listed above (→  2, 12).

The modifications are automatically stored in non-volatile memory.

Further information →  79.



### 7.6.7 Defining the Baud Rate (Baudrate)

This parameter allows to set the baud rate for the serial interface defined as «Interface» parameter value.

Figure 45:  
«General Parameter» display



Setting the baud rate:

- Select the «General Parameter» mode (if applicable) (→  39)
- Press the [next] softkey to select the «Baudrate» parameter
- Press the [] or [] softkey to select among «300» (baud), «1200» (baud), «2400» (baud), «4800» (baud), «9600» (baud (default)), and «19200» (baud)
- Press the [Return] softkey to return to the «Measurement» mode

The modifications are automatically stored in non-volatile memory.

Further information →  79.

### 7.6.8 Defining the Node Address (Address)

Figure 46:  
«General Parameter» display

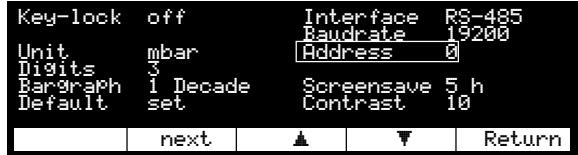

Defining the node address:

- Select the «General Parameter» mode (if applicable) (→ 39)
- Press the [next] softkey to select the «Address» parameter
- Press the [▲] or [▼] softkey to select a parameter value «0 ... 31» (node address) (default = 0)
- Press the [Return] softkey to return to the «Measurement» mode

 **NOTE**

This parameter is only available for the RS485 interface.

The modifications are automatically stored in non-volatile memory.

Further information → 79.

## 7.6.9 Screensave (Screensave)

In order for the life of the CFL lamp to be prolonged (half-life period approx. 20'000 hours), the backlighting of the LC display can be switched off automatically after an adjustable delay of 1 ... 99 hours while the LCD remains on.

Figure 47:  
«General Parameter» display

Key-lock	off	Interface	RS-485
Unit	mbar	Baudrate	19200
Digits	3	Address	0
Barograph	1 Decade	Screensave	5 h
Default	set	Contrast	10
next		▲	▼
Return			

Adjusting the screensave function:

- Select the «General Parameter» mode (if applicable) (→  39)
- Press the [next] softkey to select the «Screensave» parameter
- Press the [▲] or [▼] softkey to select «Off» or «1 ... 99» (number of hours after which the backlighting of the LCD is to be switched off after a key has been pressed) (Off = screensave deactivated (default))
- Press the [Return] softkey to return to the «Measurement» mode

 **NOTE**

Press any softkey to reactivate the background lighting. While the display is dark, all control or selection functions of the softkeys are disabled.

The modifications are automatically stored in non-volatile memory.



### 7.6.10 Display Contrast (Contrast)

This parameter allows to set the contrast of the LC display within a numeric range of 0 ... 20 according to your individual requirements, such as ambient conditions and viewing angle.

Figure 48:  
«General Parameter» display

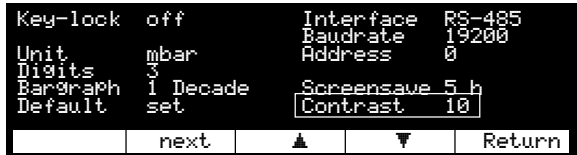

Setting the display contrast:

- Select the «General Parameter» mode (if applicable) (→  39)
- Press the [next] softkey to select the «Contrast» parameter
- Press the [▲] or [▼] softkey to select a parameter value «0 ... 20» (minimum contrast ... maximum contrast) (default = 10)
- Press the [Return] softkey to return to the «Measurement» mode

The modifications are automatically stored in non-volatile memory.

## 7.7 «Sensor Parameter» Mode

In «Sensor Parameter» mode, you can define the parameters relevant for each measurement point.

(→ Overview «Sensor Parameter» mode  32).

Figure 49:  
«Sensor Parameter» display



### 7.7.1 Selecting a Measurement Point (Sensor)

The measurement point to which the displayed parameters apply is shown as a big figure (1 ... 6) on the left of the display.

- Select the «Sensor Parameter» mode (if applicable) (→  39)
- Press the [Sensor] softkey to select the next measurement point (from 1 ... 6).

## 7.7.2 Gauge Identification (Type)

The MaxiGauge™ automatically identifies any connected Pfeiffer Vacuum gauges. For linear gauges, a measurement range is displayed additionally as parameter value \*) behind the gauge type \*\*). This parameter value has to be adjusted according to the connected gauge type.

Figure 50:  
«Sensor Parameter» display



Adjusting the measurement range:

- Select the «Sensor Parameter» mode (if applicable) (→ [39](#))
- Press the [next] softkey to select the «APR/CMR» (linear gauge types identified) parameter
- Press the [▲] or [▼] softkey to select among «0.1 mbar», «1 mbar», «10 mbar», «100 mbar», «1000 mbar» (default), «2 bar», «5 bar», «10 bar», and «50 bar»
- Press the [Return] softkey to return to the «Measurement» mode

 **NOTE**

\*) This parameter is not available for all gauge types (→ Validity table [107](#)).

\*\*) The family of linear gauges are displayed with APR/CMR.

The modifications are automatically stored in non-volatile memory.

### 7.7.3 Offset Function (Offset) (zeroing)

The offset function allows the zero of linear gauges to be aligned to the currently measured value (uncorrected output signal of the gauge) within a range of -5 ... +110% of the Full Scale setting. It affects the:

- display
- switching functions (threshold value display)
- analog outputs of the unit
- serial interfaces

Figure 51:  
«Sensor Parameter» display



Activating /  
deactivating the offset  
function

- Select the «Sensor Parameter» mode (if applicable) (→  39)
- Press the [next] softkey to select the «Offset» parameter
- Press the [▲] or [▼] softkey to select «on», (offset correction activated) or «off» (offset correction deactivated) (default) (the previously saved offset value displayed at the right hand side of the «on»/«off» parameter value)

This function can be used for two different purposes:

Zero adjustment

There are two methods for adjusting the zero of a linear gauge. Note, however, that the actual pressure must be lower than the lower limit of the measurement range of the gauge:

- Set the zero by adjusting the „ZERO“ potentiometer of the gauge (→  [14], [15])
- With the offset function of the measurement and control unit set the current pressure reading to zero

Procedure for the second method:

- at a pressure lower than the lower limit of the measurement range of the gauge, activate the offset function («ON»)
- press the [next] softkey to select the previously saved offset value (at the right hand side of «ON»); the displays of the [▲] and [▼] softkeys change to [Actual] and [Zero]
- press the [Actual] softkey to accept the currently measured value (zero deviation) as new offset value. (If you like to set the offset value to zero, press the [Zero] softkey).
- press the [Return] softkey to return to the «Measurement» mode

The advantage of the second method is that no direct access to the potentiometer of the gauge is required.

## Zeroing at any pressure

The pressure reading of the measurement and control unit can be set to zero at any pressure within the measurement range. All subsequent readings will then be relative to that pressure and may therefore be positive or negative. This method allows for monitoring of pressure variations during a process.

The procedure is the same as for the second method.



### NOTE

This parameter is not available for all gauge types  
(→ Validity table  107).

The modifications are automatically stored in non-volatile memory.

When the offset function is activated, the stored offset value is subtracted from the currently measured value.

Example:



Currently measured value	Stored offset value	Display with offset activated:	Display with offset deactivated:
		offset	
10.3	10.3	0	10.3
17.4	10.3	7.1	17.4
7.4	10.3	-2.9	7.4

 **NOTE**

When the zero of the gauge is adjusted with the „ZERO“ potentiometer, the offset function must be deactivated.

The offset values are preserved when the unit is switched off.

### 7.7.4 Activating the Degas Routine (Degas)

Contamination of the electrode system of the Compact Fullrange™ BA Gauge (PBR 260) can cause instabilities of the measured values.

The degassing routine is used for cleaning the electrode system by heating the electron collector grid to approx. 700 °C by electron bombardment.

It normally takes 3 minutes but it can be aborted at any stage.

Figure 52:  
«Sensor Parameter» display

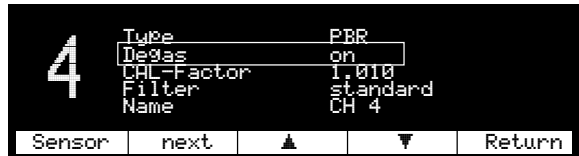

To activate or abort the degassing routine:

- Select the «Sensor Parameter» mode (if applicable) (→ 39)
- Press the [next] softkey to select the «Degas» parameter
- Press the [▲] or [▼] softkey to select «on», (Degas activated) or «off» (Degas deactivated) \*) (default)
- Press the [Return] softkey to return to the «Measurement» mode

 **NOTE**  
\*) After conclusion of the ≈3 min. degassing routine, the «Degas» parameter automatically goes back to «off» (default).

 **NOTE**

- The Degas function is only available for sensor connectors 4 to 6.
- The degassing routine can only be started («on») when the corresponding gauge is turned on.
- When Degas = «on», the status message «Degas» is displayed in «Measurement» mode.

### 7.7.5 Setting the Calibration Factor (Cal-Factor)

The calibration function allows to adjust the measured value of a gauge. It is predominantly used for correcting the measured values of logarithmic gauges for gases other than N<sub>2</sub> and for correcting the full scale values of linear gauges. The calibration factor affects the:

- display \*)
- switching functions (threshold value display) \*)
- analog outputs of the unit
- serial interfaces \*)

\*) For IMR 260, IMR 265, and PBR 260 ( $p \leq 10^{-1}$  mbar) in the hot cathode measurement range only.



Figure 53:  
«Sensor Parameter» display





Each of the six gauges can be calibrated in the following way:

- Select the «Sensor Parameter» mode (if applicable) (→  39)
- Press the [next] softkey to select the «Cal-Factor» in the following way:

For logarithmic gauges

- Press the [] or [] softkey to adjust the parameter value «0.10 ... 1.00 (default) ... 9.99» (the value increases or decreases by 0.01)
- If you hold down the softkey continually, the step size changes automatically to 0.1
- Press the [Return] softkey to return to the «Measurement» mode

For linear gauges

- Press the [] or [] softkey to adjust the parameter value «0.500 ... 1.000 (default) ... 2.000» (the value increases or decreases by 0.001)
- If you hold down the softkey continually, the step size changes automatically to 0.01
- Press the [Return] softkey to return to the «Measurement» mode

The modifications are automatically stored in non-volatile memory.



### 7.7.6 Setting the Measurement Value Filter (Filter)



The measurement value filter allows better evaluation of unstable or faulty measurement signals. It affects the:

- display
- switching functions (threshold value display)
- analog outputs of the unit
- serial interfaces

Figure 54: «Sensor Parameter» display



For each of the six gauges, a filter can be set in the following way:

- Select the «Sensor Parameter» mode (if applicable) (→  39)
- Press the [next] softkey to select the «Filter» parameter
- Press the [] or [] softkey to select among «fast», «slow» and «standard» (default) parameter value (→ following explanations)
- Press the [Return] softkey to return to the «Measurement» mode

The modifications are automatically stored in non-volatile memory.

#### Standard Filter

Default setting with a good relationship between response and sensitivity of the display and the switching functions to changes in measured values.

Figure 55: Measurement value filter Standard

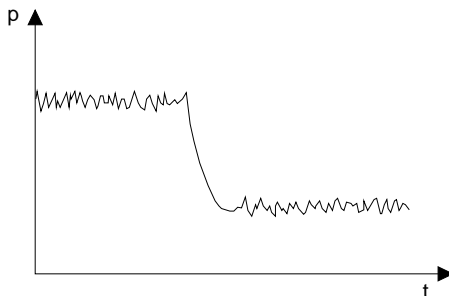

### Slow Filter

Choose «slow» if the display and the switching functions should not respond to small changes in measured values. As a consequence, the unit will respond more slowly to changes in measured values.

Figure 56:  
Measurement value filter Slow

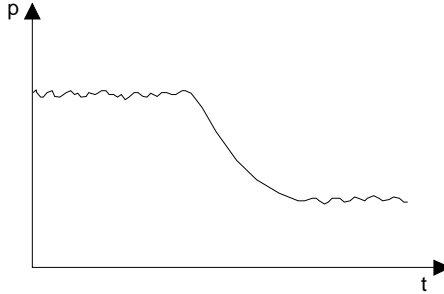

### Fast Filter

Choose «fast» if the display and the switching functions should respond quickly to fluctuations in measured values. As a consequence, the unit will respond faster to interference in measured values.

Figure 57:  
Measurement value filter Fast

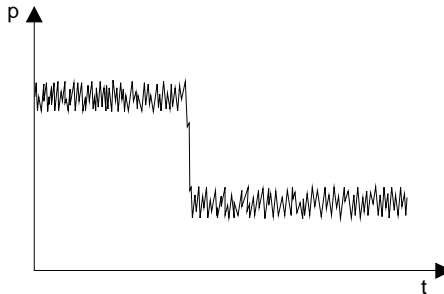

### 7.7.7 Defining the Measurement Point Name (Name)

The measurement point name is shown on the display as CH 1, CH 2 ... CH 6 (CH = channel).

These 4 characters can be overwritten with any combination of characters comprising letters, digits or spaces.

This may be useful, for instance, for differentiating gauges in a system or for certain functional designations.

Figure 58:  
«Sensor Parameter» display



Defining the measurement point name:

- Select the «Sensor Parameter» mode (if applicable) (→  39)
- Press the [next] softkey to select the «Name» parameter (the cursor jumps automatically to the first digit)
- Press the [▲] or [▼] softkey to select a parameter value «A ... Z» (default: C), «0 ... 9», « », (first character of the name)
- Press the [next] softkey to select the next digit
- Press the [▲] or [▼] softkey to select a parameter value «A ... Z» (default: H), «0 ... 9», « », (second character of the name)
- Select the third (default: space) and the fourth (default: digit 1 ... 6) character of the name as described above
- Press the [Return] softkey to return to the «Measurement» mode

The modifications are automatically stored in non-volatile memory.



## 7.8 «Sensor Control» Mode

### Gauge control possibilities

In «Sensor Control» mode, you can define how cold cathode, and FullRange™ and ionization gauges are turned on/off by other gauges or control devices.

(→ Overview «Sensor Control» mode  33).

When defining the control options, note that:

- only the gauge control configurations shown on table «Sensor Control» (→  69 ff) are valid
- the Pirani and all linear gauges are always active after the MaxiGauge™ has been switched on
- «Hot Start» means that the gauge is automatically turned on when the power is switched on. After power on the hot start control settings (→  73) are applied for turning the gauge off. This operating mode allows for automatic continuation of the measurement after a power failure.
- a gauge cannot be turned off by a «Hot Start».
- a gauge cannot turn itself on when a certain pressure is reached
- both, cold cathode and linear gauges for a full scale pressure range  $\geq 1000$  mbar (1 bar) cannot be used as control sources
- the six «Ext-Ctl» inputs are permanently assigned to the six gauge ports.



#### NOTE

<sup>\*)</sup> This parameter is not available for all gauge types (→ Validity table  107).

Figure 59:  
Table «Sensor Control»

Controlled sensor		Controlling source		
		TPR/PCR	PKR	IMR / PBR
IMR/ PBR	<b>on</b>	1 ... 1E-3	1 ... 1E-5	-
	<b>off</b>	1 ... 1E-3	1 ... 1E-5	-
IKR	<b>on</b>	1E-2 ... 1E-3	1E-2 ... 1E-5	1E-2 ... 5E-10
	<b>off</b>	1E-2 ... 1E-3	1E-2 ... 1E-5	1E-2 ... 5E-10

Controlled sensor		Controlling source		
		APR / CMR / ACR 1 mbar F.S.	APR / CMR / ACR 10 mbar F.S.	APR / CMR / ACR 100 mbar F.S.
IMR/ PBR	<b>on</b>	1 ... 1E-3	1 ... 1E-2	1 ... 1E-1
	<b>off</b>	1 ... 1E-3	1 ... 1E-2	1 ... 1E-1
IKR	<b>on</b>	1E-2 ... 1E-3	1E-2	-
	<b>off</b>	1E-2 ... 1E-3	1E-2	-

Controlled sensor		Controlling source		
		Extern	Manual	Hot Start
PKR	<b>on</b>	CTL 1 ... 6	Yes	<b>Yes</b>
	<b>off</b>	CTL 1 ... 6	Yes	-
IMR/ PBR	<b>on</b>	CTL 1 ... 6	Yes	<b>Yes</b>
	<b>off</b>	CTL 1 ... 6	Yes	-
IKR	<b>on</b>	CTL 1 ... 6	<b>Yes</b>	Yes
	<b>off</b>	CTL 1 ... 6	<b>Yes</b> or 1E-2...1E-5*)	1E-2...1E-5*)

**Bold:** default values

- \*) self-monitoring
- no control possibility

The values such as 1 ... 1E-3 specified in the above table refer to mbar and correspond to the adjustable setpoints at which the gauges are turned on or off.

### 7.8.1 Selecting the Controlled Gauge (Sensor)

The controlled gauge to which the following parameters access is shown as a big figure on the left of the display.

Figure 60:  
«Sensor Control» display

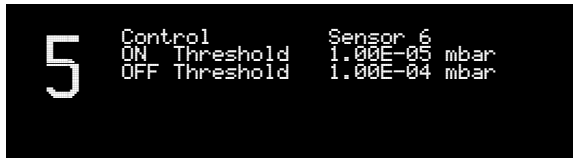

Selecting another measurement point:

- Press the [Sensor] key to select the next higher measurement point (from 1 ... 6).

### 7.8.2 Selecting the Controlling Source (Control)

The controlling source is shown in the upper display line at the right of the «Control» parameter.

To select the controlling source, proceed as follows (in this example, the default gauge is «Sensor 6»):

- Select the «Sensor Control» mode (if applicable) (→  39)
- Press the [next.] softkey to select the «Control» parameter
- Press the [▼] softkey to select the «Sensor 5 ... 1» parameter value (if the selected gauge cannot be used as controlling source, the error message «no Sensor Control» is displayed).
- Press the [▲] softkey to select among «Extern», «Manual» and «Hotstart»

Once the controlling source has been selected, its set-points for turning the controlled gauge on / off can be defined. The following sections explain how this is done.

### 7.8.3 Setting the «Sensor 1 ... 6» Control

Setting the parameters:

- Select «Control» «Sensor 1 ... 6» as controlling source (→ 70)
  - Press the [next] softkey to select «ON Threshold»
  - Press the [▲] or [▼] softkey to increase / decrease the parameter value<sup>\*)</sup>
  - Press the [next] softkey to select «OFF Threshold»
  - Select the [▲] or [▼] softkey to increase / decrease the parameter value<sup>\*)</sup>
  - Press the [Return] softkey to return to the «Measurement» mode
- <sup>\*)</sup> A minimum hysteresis of 10 % for logarithmic and 1 % for linear gauges is automatically applied (→ NOTES, 44, 45, 46).

### 7.8.4 Setting the «Extern» Control

The six «Ext-Ctl» inputs are permanently assigned to the six gauge ports.

When the external control source becomes «low», the controlled gauge turns on, when the external control source becomes «high», the controlled gauge turns off.

This behavior is factory set and cannot be modified.

Figure 61:  
«Control Extern» display

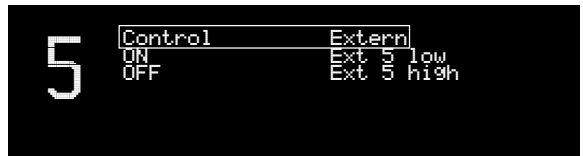

Setting the parameters:

- Select «Control» «Extern» as controlling source (→ 70)
- Press the [Return] softkey to return to the «Measurement» mode



### 7.8.5 Setting the «Manual» Control

You can turn on the controlled gauge with the [Sen-on] softkey and turn it off with the [Sen-off] softkey. If a corresponding setpoint has been defined, the gauge can also be turned off automatically in the event of a pressure rise.



Figure 62:  
«Control Manual» display



Setting the parameters:

- Select «Control» «Manual» as controlling source (→ 70)
- Press the [next] softkey to select the «OFF» parameter
- Press the [] or [] softkey to select the «Key Sen-off» (unit is turned off with a softkey) or «Selfcontrol» (self-monitoring) parameter value

When self-monitoring is selected, a fourth parameter line «OFF Threshold» is displayed. To define a setpoint, proceed as follows:

- Press the [next] softkey to select the «OFF Threshold» parameter
- Press the [] or [] softkey to increase /decrease the parameter value
- Press the [Return] softkey to return to the «Measurement» mode



## 7.8.6 Setting the «Hot.start.» Control

When the unit is switched on, the controlled gauge is turned on automatically, and when the unit is switched off, it is turned off, too. However, the controlled gauge can also turn off itself in the event of a pressure rise (Selfcontrol).

Figure 63:  
«Hot.start.» display



Setting the parameters:

- Select «Control» «Hot.start.» as controlling source (→ 70)
- Press the [next] softkey to select the «OFF» parameter
- Press the [▲] or [▼] softkey to select the «Power off» (measurement point is turned off when the unit is switched off) or «Selfcontrol» (self-monitoring) parameter

when self-monitoring is selected, a fourth parameter line «OFF Threshold» is displayed. To define the setpoint, proceed as follows:

- Press the [next] softkey to select the «OFF Threshold»
- Press the [▲] or [▼] softkey to increase / decrease the parameter value
- Press the [Return] softkey to return to the «Measurement» mode

## 7.9 Status Messages

Status messages are not to be confounded with error messages. They only indicate the system status. If status messages are displayed instead of measured values, the received measurement signal is faulty.

Figure 64:  
Status messages in  
«Measurement» mode

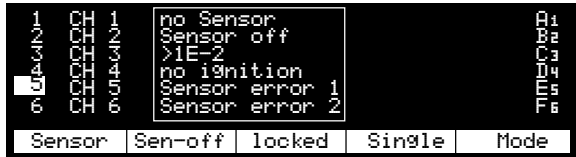

(Status message)

When status messages are displayed, proceed as follows:

- Find out why the received measurement signal is faulty

After the problem is remedied, the measured value is automatically displayed again.

Figure 65:  
Status messages with different  
gauges

locked *)						Status message
TPR PCR	IKR	PKR	APR CMR ACR	IMR	PBR	Meaning
✓	✓	✓	✓	✓	✓	Attempted entry with activated input lock

\*) In softkey display bar

no Sensor						Status message
TPR PCR	IKR	PKR	APR CMR ACR	IMR	PBR	Meaning
	✓	✓	✓	✓	✓	No gauge connected

Sensor off						Status message
TPR PCR	IKR	PKR	APR CMR ACR	IMR	PBR	Meaning
	✓	✓		✓	✓	IKR, IMR, PKR, PBR turned off

>"range"						Status message
TPR PCR	IKR	PKR	APR CMR ACR	IMR	PBR	Meaning
✓	✓	✓	✓	✓	✓	Overrange

<"range"						Status message
TPR PCR	IKR	PKR	APR CMR ACR	IMR	PBR	Meaning
✓	✓	✓	✓	✓	✓	Underrange

Sensor error 1						Status message
TPR PCR	IKR	PKR	APR CMR ACR	IMR	PBR	Meaning
✓	✓	✓	✓	✓	✓	Measured value in the lower error range

Sensor error 2						Status message
TPR PCR	IKR	PKR	APR CMR ACR	IMR	PBR	Meaning
✓	✓	✓	✓	✓	✓	Measured value in the upper error range



**NOTE**

The «Sensor error 1 » and «Sensor error 2 » status messages do not necessarily refer to the connected gauges 1 and 2 (see above for meaning of these status messages).

## 7.10 Error Messages

Error messages are flashing in the display bar above the middle softkey: Irregularities or disturbances have occurred. The error relay switches over (→ 22).

Figure 66:  
EEPROM error in  
«Measurement» mode



(Error message is flashing)

When error messages are displayed, proceed as follows:

Acknowledging errors:

Acknowledging error messages

- Press the middle softkey. The error message is thus erased and the next error message appears (if applicable)

After the error has been acknowledged, the error relay switches back to its original position (→ 22).

- If the error message persists, switch the unit off and on again



### NOTE











Wait at least 10 seconds before turning the unit on again in order for it to correctly initialize itself.

Depending on the setting of the system monitoring, certain error messages (e.g. watchdog errors) are automatically acknowledged after 2 seconds (→ 111) or they have to be manually acknowledged.

The meanings of the error messages are listed in the following table.

If the problem cannot be remedied, make a note of the error message(s) and contact your nearest Pfeiffer Vacuum Service Center.

Figure 67:  
Error message table

Display	Possible cause	Remedy
No display	Power cable interrupted	Check the power cable
	Mains voltage missing / too high / too low	Check mains voltage
Display dark	Screensave activated (→  56)	Press a softkey
	Lamp defective (life)	Replace the lamp
WDT	Operating system error (watchdog error)	Acknowledge (→  76)
	You have switched the unit on to soon after switching it off	Switch the unit off, wait for 10 seconds and switch it on again
TASK	Operating system error (task fail error)	Acknowledge (→  76)
IDLE	Operating system error (idle error)	Acknowledge (→  76)
STACK	Operating system error (stack overflow error)	Acknowledge (→  76)
RAM	RAM error (data memory)	Acknowledge (→  76)
EPROM	EPROM error (program memory)	Acknowledge (→  76)
EEPROM	EEPROM error (parameter memory)	Acknowledge (→  76)
Display	Display-RAM error (display memory)	Acknowledge (→  76)
KEY	Softkey error	Acknowledge (→  76)
ID1...ID6	Break in the line to the corresponding gauge or line has been disconnected during operation *)	Check the gauge cable in question Acknowledge (→  76)

\*) If the cause has not been remedied, the «no Sensor» status message is displayed.

Display	Possible cause	Remedy
SE1...SE6	Sensor error *)	Check according to the following examples Acknowledging error messages (→  76)
	Pirani, Pirani/Capacitance: No supply  Measurement element faulty	Check supply and cable  Maintain or exchange the gauge
	FullRange™ Gauge: No supply  Pirani measurement element faulty	Check supply and cable  Maintain or exchange the gauge
	Cold cathode gauge: No supply	Check supply and cable
	Linear gauge: No supply	Check supply and cable
	Compact Process Ion Gauge: No Supply voltage	Check supply and cable

\*) At the same time, the status message  
«Sensor error 1» (in the lower error range) or  
«Sensor error 2» (in the upper error range) is displayed (→  74).

## 8 Communication

### 8.1 Serial Interfaces

Serial interfaces are used for communication between the MaxiGauge™ and a computer (HOST). A terminal can be connected for test purposes.

#### 8.1.1 Connection Diagrams

RS232C/422  
Serial interface port

Pin assignment

- 1 Chassis
- 2 RXD (RS232C)
- 3 TXD (RS232C)
- 4 not connected
- 5 Signal ground
- 6 RX+ (RS422)
- 7 RX- (RS422)
- 8 TX+ (RS422)
- 9 TX- (RS422)

D-Sub, 9-pin, male

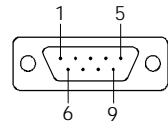

Front view

RS485/422 isol.  
Serial interface port

Pin assignment

- 1 TX+
- 2 TX-
- 3 RX+
- 4 not connected
- 5 not connected
- 6 RX-
- 7 not connected
- 8 Isolation ground

RJ45, 8-pin

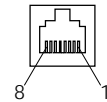

Front view

## 8.1.2 Connection Cable

RS232C/422  
Serial interface port

- Use shielded cable only



**CAUTION**

Only one of the two interfaces may be connected.

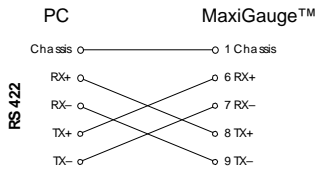
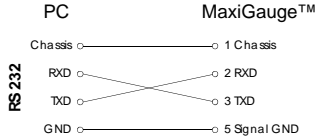

RS485/4221 isol.  
Serial interface port

- Use shielded RJ45 cable (STP)
- Wiring with cable pairs 1/2, 3/6, 4/5 and 7/8



**CAUTION**

The voltage difference between the Isol. GND and the chassis may be max. 25 V for each MaxiGauge™.

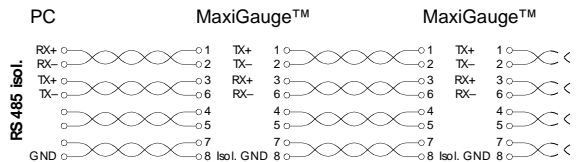
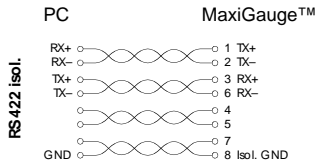



**8.1.3 Data Transmission**      The data transmission is bi-directional (master-slave).

Data format                      1 Start bit, 8 data bits, 1 stop bit, no parity bit,  
no hardware handshake

Abbreviations and  
symbols used

Symbol	Meaning	Dec.	Hex.
HOST	Computer or terminal		
[...]	Optional elements		
ASCII	American Standard Code for Information Interchange		
<ETX>	END OF TEXT (CTRL C) Reset the interface	3	03
<CR>	CARRIAGE RETURN Go to beginning of line	13	0D
<LF>	LINE FEED Advance by one line	10	0A
<ENQ>	ENQUIRY	5	05
>	Request for data transmission		
<ACK>	ACKNOWLEDGE Positive report signal	6	06
<NAK>	NEGATIVE ACKNOWLEDGE Negative report signal	21	15
<ESC>	ESCAPE	27	1B

Flow control

After each ASCII string the HOST must wait for a confirmation (<ACK> or <NAK>) <CR><LF> to ensure that the input buffer of the MaxiGauge™ is empty.

The input buffer of the HOST must have a capacity of at least 64 bytes.

Communication protocol

Transmission format

Messages are transmitted to the MaxiGauge™ as ASCII strings in the form of mnemonics and parameters. All mnemonics comprise three ASCII characters.

Spaces are ignored. <ETX> clears the input buffer in the MaxiGauge™.

The input is terminated by <CR> or <LF> or <CR><LF> ("end of message"), and evaluation in the MaxiGauge™ is subsequently started.



**NOTE**

Do not transmit any LINE FEEDS (<LF>) via the RS485 half duplex line for fear they could cause data collisions on the bus.

The RS232C, RS422, RS422I and RS485 (fullduplex) interfaces permit transmitting LINE FEEDS (<LF>). However, not transmitting them makes data transmission faster.

The tables on 85 ff are applicable to the mnemonics and parameters. The maximum number of digits, the data formats and admissible value ranges are also specified there.

Transmission protocol

HOST	MaxiGauge™	Explanation
Mnemonics [and parameters] <CR>[<LF>]	—————>	HOST transmits message with "end of message"
<—————	<ACK><CR><LF>	MaxiGauge™ transmits positive acknowledgment of a received message

The current parameters of the function can be inquired by leaving out the [parameters].

Reception format

When requested with a mnemonics, the MaxiGauge™ transmits the measurement data or parameters as an ASCII string to the HOST.

<ENQ> must be transmitted to request the transmission of an ASCII string. Additional strings, according to the last selected mnemonic, are read out by repetitive transmission of <ENQ>.

If <ENQ> is received without a valid request, the error status is transmitted.

Reception protocol	HOST	MaxiGauge™	Explanation
	Mnemonics [and parameters] <CR>[<LF>]	—————>	HOST transmits message with "end of message"
		<————— <ACK><CR><LF>	MaxiGauge™ transmits positive acknowledgment of a received message
	<ENQ>	—————>	The HOST invites the MaxiGauge to transmit data
	Measurement values or parameters	<————— <CR><LF>	MaxiGauge™ transmits data with "end of message"
	<ENQ>	—————>	The HOST invites the MaxiGauge to transmit data
	Measurement values or parameters	<————— <CR><LF>	MaxiGauge™ transmits data with "end of message"

**Error processing** All messages received are verified in the MaxiGauge™. If an error is detected, a negative acknowledgment <NAK> is output. The fault condition can subsequently be read out (→  97).

**Error recognition protocol**

HOST	MaxiGauge™	Explanation
Mnemonics [and parameters] <CR>[<LF>]	—————>	HOST transmits message with "end of message"
***** Transmission or programming error *****		
	<————— <NAK><CR><LF>	MaxiGauge™ transmits negative acknowledgment of a received message
Mnemonics [and parameters] <CR>[<LF>]	—————>	HOST transmits message with "end of message"
	<————— <ACK><CR><LF>	MaxiGauge™ transmits positive acknowledgment of a received message

## 8.2 Mnemonics

			→ 
BAU	Baud rate	Baud rate	95
CAx	Calibration factor Sensor x	Calibration factor sensor x (1 ... 6)	92
CID	Measurement point names	Measurement point names	88
DCB	Display control Bargraph	Bargraph	89
DCC	Display control Contrast	Display control contrast	90
DCD	Display control Digits	Display digits	88
DCS	Display control Screensave	Display control screensave	90
DGS	Degas	Degas	93
ERR	Error Status	Error status	97
FIL	Filter time constant	Filter time constant	92
FSR	Full scale range of linear sensors	Full scale range of linear sensors	93
LOC	Parameter setup lock	Parameter setup lock	91
NAD	Node (device) address for RS485	Node (device) address for RS485	96
OFC	Offset correction	Offset correction	93
PNR	Program number	Program number	98
PRx	Status, Pressure sensor x (1 ... 6)	Status, Pressure sensor x (1 ... 6)	88
PUC	Underrange Ctrl	Underrange control	91
RSX	Interface	Interface	94
SAV	Save default	Save default	94
SCx	Sensor control	Sensor control	87
SEN	Sensor on/off	Sensor on/off	86
SPx	Set Point Control Source for Relay x	Threshold value setting, Allocation	90
SPS	Set Point Status A,B,C,D,E,F	Set point status	91
TAI	Test program A/D Identify	Test A/D converter identification inputs	100
TAS	Test program A/D Sensor	Test A/D converter measurement value inputs	100
TDI	Display test	Display test	98
TEE	EEPROM test	EEPROM test	100
TEP	EPROM test	EPROM test	99
TID	Sensor identification	Sensor identification	101
TKB	Keyboard test	Keyboard test	99
TRA	RAM test	RAM test	99
UNI	Unit of measurement (Display)	Unit of measurement (pressure)	89
WDT	Watchdog and System Error Control	Watchdog and system error control	101

" Transmit "  
" Receive "

"Transmit": Data transfer from HOST to MaxiGauge™  
"Receive": Data transfer from MaxiGauge™ to HOST

## 8.2.1 Measurement Values

Sensor on / off

Transmit:                    **SEN** [,x,x,x,x,x,x] <CR>[<LF>]  
                                   └─ Sensors 1 ... 6  
                                     x = 0 → No change  
                                     1 → Off  
                                     2 → On

Receive:                    <ACK><CR><LF>

Transmit:                    <ENQ>

Receive:                    x,x,x,x,x,x <CR><LF>  
                                   └└└└└└└└ Status Sensors 1 ... 6

 **NOTE**  
 Not all sensor types can be switched on and off.

## Sensor control

Transmit:

**SCx** [*x,x,x,x*E±*yy,x,x*E±*yy*] <CR><LF>

- └─ Switching off value
- └─ Switching on value
- └─ Switch off the controlling source of the sensor
  - x = 0 → Sensor 1
  - 1 → Sensor 2
  - 2 → Sensor 3
  - 3 → Sensor 4
  - 4 → Sensor 5
  - 5 → Sensor 6
  - 6 → External control
  - 7 → Manual (Default)
- └─ Switch on the controlling source of the sensor
  - x = 0 → Sensor 1
  - 1 → Sensor 2
  - 2 → Sensor 3
  - 3 → Sensor 4
  - 4 → Sensor 5
  - 5 → Sensor 6
  - 6 → External control
  - 7 → Manual (Default)
  - 8 → Hot start
- └─ Controlled sensor    x = A → Sensor 1
  - B → Sensor 2
  - C → Sensor 3
  - D → Sensor 4
  - E → Sensor 5
  - F → Sensor 6

Receive:

<ACK><CR><LF>

Transmit:

<ENQ>

Receive:

*x,x,x,xx*E±*yy,x,xx*E±*yy* <CR><LF>

- └─ Switching off value
- └─ Switching on value
- └─ Switch off the controlling source of the gauge
- └─ Switch on the controlling source of the gauge

## Status and pressure

Transmit: **PRx <CR>[<LF>]**  
 └─ Sensor x = 1 ... 6

Receive: <ACK><CR><LF>  
 Transmit: <ENQ>

Receive: x,x.xxxEsx <CR><LF>  
 └─ Measurement value (always exponential format)  
 └─ Status  
 x = 0 → Measurement data okay  
 1 → Underrange  
 2 → Overrange  
 3 → Sensor error  
 4 → Sensor off  
 5 → No sensor  
 6 → Identification error

## Digits

Transmit: **DCD [,x] <CR>[<LF>]**  
 └─ Digits x = 2 → Display x.x (2 digits) (default)  
 3 → Display x.xx (3 digits)

Receive: <ACK><CR><LF>  
 Transmit: <ENQ>

Receive: x <CR><LF>  
 └─ Digits

## Measurement point names

Transmit: **CID [,xxxx,xxxx,xxxx,xxxx,xxxx,xxxx] <CR>[<LF>]**  
 └─ Measurement point name 6  
 └─ Measurement point name 5  
 └─ Measurement point name 4  
 └─ Measurement point name 3  
 └─ Measurement point name 2  
 └─ Measurement point name 1



 **NOTE**  
 All channel names are ASCII strings (A ... Z; 0 ... 9).  
 Blanks (spaces) are ignored.

Receive: <ACK><CR><LF>  
 Transmit: <ENQ>

Receive: xxx,xxx,xxx,xxx,xxx,xxx <CR><LF>  
 | | | | | | Measurement point names

## 8.2.2 Display

Unit of measurement

 **NOTE**  
 The selected measurement unit has only an effect on the display, i.e. it does not affect the accuracy of the measurement.

Transmit: **UNI** [,x] <CR>[<LF>]  
     └─ Measurement unit x = 0 → mbar (Default)  
           1 → Torr  
           2 → Pascal

Receive: <ACK><CR><LF>  
 Transmit: <ENQ>

Receive: x <CR><LF>  
     └─ Measurement unit

Bargraph

Transmit: **DCB** [,x] <CR>[<LF>]  
     └─ Bargraph x = 0 → Off (default)  
           1 → Bargraph = Measurement range  
           2 → Bargraph = 1 decade

Receive: <ACK><CR><LF>  
 Transmit: <ENQ>

Receive: x <CR><LF>  
     └─ Bargraph

## Contrast

Transmit: DCC [,xx] <CR>[<LF>]  
 └─ Contrast x = 0 ... 20 → Contrast dark ... light  
 (Default = 10 (med.))

Receive: <ACK><CR><LF>  
 Transmit: <ENQ>

Receive: xx <CR><LF>  
 └─ Contrast

## Screensave

Transmit: DCS [,xx] <CR>[<LF>]  
 └─ Screensave  
 x = 0 → Screensave off (default)  
 1 ... 99 → Screensave after 1 ... 99 h

Receive: <ACK><CR><LF>  
 Transmit: <ENQ>

Receive: xx <CR><LF>  
 └─ Screensave

## 8.2.3 Switching Functions

### Threshold value setting, Allocation

Transmit: SPx [,x,x.xxEsx,x.xxEsx] <CR>[<LF>]  
 └─ Upper threshold [mbar]  
 (default = 9.00E-11)  
 └─ Lower threshold [mbar]  
 (always exponential format)  
 (default = 1.00E-11)  
 └─ Source x = 0 ... 5 → sensors 1 ... 6  
 └─ Switching function (Relay) x = 1 ... 6 → A ... F

Receive: <ACK><CR><LF>  
 Transmit: <ENQ>

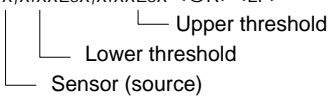
Receive: x,x.xxEsx,x.xxEsx <CR><LF>  

### Set point status

Transmit: SPS <CR>[<LF>]

Receive: <ACK><CR><LF>  
 Transmit: <ENQ>

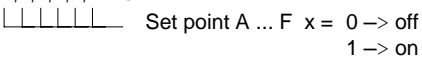
Receive: x,x,x,x,x,x <CR><LF>  

### Underrange control

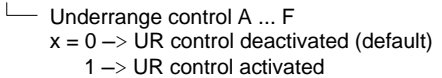
Transmit: PUC [,x,x,x,x,x,x] <CR>[<LF>]  

Receive: <ACK><CR><LF>  
 Transmit: <ENQ>

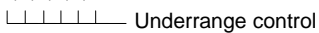
Receive: x,x,x,x,x,x <CR><LF>  

## 8.2.4 Parameters

### Entry lock function

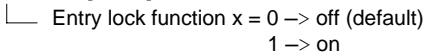
Transmit: LOC [,x] <CR>[<LF>]  

Receive: <ACK><CR><LF>  
 Transmit: <ENQ>

Receive: x <CR><LF>  
 └─ Entry lock function

### Filter time constants

Transmit: **FIL** [,x,x,x,x,x,x] <CR><LF>  
 └─ Filter time constant sensors 1 ... 6  
 x = 0 → fast  
 1 → standard (default)  
 2 → slow

Receive: <ACK><CR><LF>  
 Transmit: <ENQ>

Receive: x,x,x,x,x,x <CR><LF>  
 └─ Filter time constant

### Calibration factor

Transmit: **CAX** [,x.xxx] <CR><LF>  
 └─ Calibration factor 0.100 ... 9.999  
 for logarithmic sensors (default = 1.000)  
 Calibration factor 0.500 ... 2.000  
 for linear sensors (default = 1.000)  
 └─ Sensor x = 1 ... 6

Receive: <ACK><CR><LF>  
 Transmit: <ENQ>

Receive: x.xxx <CR><LF>  
 └─ Calibration factor

### Offset correction

Transmit: **OFC** [,x,x,x,x,x,x] <CR>[<LF>]  
 └─ Offset correction sensors 1 ... 6  
 x = 0 → off (default)  
 1 → activated  
 2 → actual measurement value = offset value

Receive: <ACK><CR><LF>  
 Transmit: <ENQ>

Receive: x,x,x,x,x,x <CR><LF>  
 └─ Offset correction

### Measurement range

 **NOTE**

For linear gauges, the maximum pressure should be defined (full scale value). For logarithmic gauges the measurement range is detected automatically.

Transmit: **FSR** [,x,x,x,x,x,x] <CR>[<LF>]  
 └─ full scale range sensors 1 ... 6  
 x = 0 → 1 mbar  
 1 → 10 mbar  
 2 → 100 mbar  
 3 → 1000 mbar (default)  
 4 → 2 bar  
 5 → 5 bar  
 6 → 10 bar  
 7 → 50 bar  
 8 → 0.1 mbar

Receive: <ACK><CR><LF>  
 Transmit: <ENQ>

Receive: x,x,x,x,x,x <CR><LF>  
 └─ Measurement ranges

### Degas

Transmit: **DGS** [,0,0,0,x,x,x] <CR>[<LF>]  
 └─  
 └─ x = 0 → Degas off  
 1 → Degas on  
 Sensors 1 ... 3: no degas

Receive: <ACK><CR><LF>  
 Transmit: <ENQ>

Receive: 0,0,0,x,x,x <CR><LF>  
           └─ Degas status

### Default

Transmit: **SAV** [,1] <CR>[<LF>]  
           └─ Activate the factory setting

Receive: <ACK><CR><LF>

## 8.2.5 Interfaces

### Interface

This functions is only useful if several interfaces are connected to the unit.

Transmit: **RSX** [,x] <CR>[<LF>]  
           └─ Interface x = 0 → RS232C (default)  
               1 → RS422  
               2 → RS422I isolated  
               3 → RS485 isolated



#### NOTE

The RS485 interface allows to assign addresses to the connected units. The node (or device) address of each unit can be defined (→ 55). When replacing a unit, don't forget to enter the corresponding address number (→ 96).

Receive: <ACK><CR><LF>  
 Transmit: <ENQ>



#### NOTE

In order not to interrupt the communication, set the HOST to the same interface as the MaxiGauge™.

Receive: x <CR><LF>  
└ Interface

### Baud rate

Transmit: **BAU** [,x] <CR>[<LF>]  
└ Baud rate x = 0 → 300 baud  
1 → 1200 baud  
2 → 2400 baud  
3 → 4800 baud  
4 → 9600 baud (default)  
5 → 19200 baud



#### NOTE

As soon as the new baud rate has been entered, the report signal is transmitted at the new baud rate.

Receive: <ACK><CR><LF>  
Transmit: <ENQ>

Receive: x <CR><LF>  
└ Baud rate

## RS485 node address

Transmit: **NAD** xx <CR>[<LF>]  
     └─ Node address of the unit  
         x = 00 ... 31 → Node address 00 ... 31

Receive: <ACK><CR><LF>  
 Transmit: <ENQ>

Receive: xx <CR><LF>  
     └─ Node address of the unit



### NOTE

Do not transmit any LINE FEEDS (<LF>) via the RS485 half duplex line for fear they could cause data collisions on the bus.

The RS232C, RS422, RS422I and RS485 (fullduplex) interfaces permit transmitting LINE FEEDS (<LF>). However, not transmitting them makes data transmission faster.

## Addressing the unit

Entering the corresponding node address connects the unit connects to the HOST. The other units release the bus.

Transmit: <ESC>xx  
     └─ Node address of the unit  
         xx = 00 ... 31



### NOTE

All node addresses have two digits (00 ... 31). The address must always be transmitted when a different unit is to be accessed.



## 8.2.6 Error Messages

Error status

Transmit: ERR <CR>[<LF>]

Receive: <ACK><CR><LF>

Transmit: <ENQ>

Receive: xxxxx,xxxxx <CR><LF>

```

└─ Error status
    xxxxx = 0 → No error
    1 → Sensor 1: Measurement error
    2 → Sensor 2: Measurement error
    4 → Sensor 3: Measurement error
    8 → Sensor 4: Measurement error
    16 → Sensor 5: Measurement error
    32 → Sensor 6: Measurement error
    512 → Sensor 1: Identification error
    1024 → Sensor 2: Identification error
    2048 → Sensor 3: Identification error
    4096 → Sensor 4: Identification error
    8192 → Sensor 5: Identification error
    16384 → Sensor 6: Identification error

└─ Error status
    xxxxx = 0 → No error
    1 → Watchdog has responded
    2 → Task fail error
    4 → IDCX idle error
    8 → Stack overflow error
    16 → EPROM error
    32 → RAM error
    64 → EEPROM error
    128 → Key error
    4096 → Syntax error
    8192 → Inadmissible parameter
    16384 → No hardware
    32768 → Fatal error
    
```

## 8.2.7 Test Programs for Pfeiffer Vacuum Service Specialists



### NOTE

Some test programs take several seconds to transmit a report signal.

Once a test program is started, the «Test» mode remains active until the unit is switched off.

### Program version

Transmit: PNR <CR>[<LF>]

Receive: <ACK><CR><LF>

Transmit: <ENQ>

Receive: BGxxxxxx-x

└─ Index (-, A, B ... Z)  
└─ Program version

### Display test

Transmit: TDI <CR>[<LF>]

Receive: <ACK><CR><LF>

Transmit: <ENQ>

Receive: xxxxx,xxxxx <CR><LF>

└─ Error status →  97

## Keyboard test

Transmit: **TKB** <CR>[<LF>]

Receive: <ACK><CR><LF>

Transmit: <ENQ>

Receive: xx <CR><LF>

└ xx = 1 → Bit 0 = 1 Key 1 pressed  
           2 → Bit 1 = 1 Key 2 pressed  
           4 → Bit 2 = 1 Key 3 pressed  
           8 → Bit 3 = 1 Key 4 pressed  
          16 → Bit 4 = 1 Key 5 pressed  
          nn → nn = Sum of the values of the pressed  
                   keys

## RAM test

Transmit: **TRA** <CR>[<LF>]

Receive: <ACK><CR><LF>

Transmit: <ENQ>

Receive: xxxxx,xxxxx <CR><LF>

└ Error status →  97

## EPROM test

Transmit: **TEP** <CR>[<LF>]

Receive: <ACK><CR><LF>

Transmit: <ENQ>

Receive: xxxxx,xxxxx <CR><LF>

└ Error status →  97

EEPROM test

	<b>CAUTION</b>
This test should not be continually repeated (life time of the EEPROM).	

Transmit:                    **TEE** <CR>[<LF>]  
 Receive:                      <ACK><CR><LF>  
 Transmit:                      <ENQ>  
  
 Receive:                      xxxxx,xxxxx <CR><LF>  
                                     └ Error status →  97

Test A/D converter  
identification inputs

Transmit:                    **TAI** <CR>[<LF>]  
 Receive:                      <ACK><CR><LF>  
 Transmit:                      <ENQ>  
  
 Receive:                      x.xxx,x.xxx,x.xxx,x.xxx,x.xxx,x.xxx<CR><LF>  
                                     └ Identification voltage sensors 1 ... 6

Test A/D converter  
measurement value  
inputs

Transmit:                    **TAS** <CR>[<LF>]  
 Receive:                      <ACK><CR><LF>  
 Transmit:                      <ENQ>  
  
 Receive:                      x.xxx,x.xxx,x.xxx,x.xxx,x.xxx,x.xxx<CR><LF>  
                                     └ Measurement voltage sensors 1 ... 6

## Sensor identification

Transmit: **TID** <CR>[<LF>]

Receive: <ACK><CR><LF>

Transmit: <ENQ>

Receive: xxxxxxxx,xxxxxxx, ... ,xxxxxxx <CR><LF>

└─ Identification sensors 1 ... 6

xxxx = TPR/PCR	(Pirani Gauge or Pirani Capacitance Gauge)
IKR9	(Cold cathode to 10 <sup>-9</sup> mbar)
IKR11	(Cold cathode to 10 <sup>-11</sup> mbar)
PKR	(FullRange™ CC)
APR/CMR	(Linear sensor)
IMR	(Pirani / High Pressure)
PBR	(FullRange™ BA)
no Sensor	(No sensor)
no Ident	(No identification)

## Watchdog control

Transmit: **WDT** [,x] <CR>[<LF>]

└─ Watchdog control

x = 0 → automatic acknowledgment (default)

1 → manual acknowledgment

Receive: <ACK><CR><LF>

Transmit: <ENQ>

Receive: x <CR><LF>

└─ Watchdog control

## 9 Maintenance and Care

### 9.1 Personnel

No special skills are required for care and cleaning of the external equipment surfaces.



#### Specialists

Persons cleaning the inside of the unit with compressed air need to be informed on the dangers inherent in handling compressed air.

For cleaning and handling the connected gauges, the special instructions concerning cleanliness and damage prevention apply (→ corresponding  of gauge used).

### 9.2 Cleaning

#### External cleaning

A slightly moist cloth will usually do. Do not use under any circumstances any aggressive or scouring cleaning agents. Do not allow water to penetrate into the unit. Allow the unit to dry thoroughly before putting it into operation again.

#### Internal cleaning

In a very dusty environment, the dust has to be periodically removed from the inside of the unit. Carefully blow the dust out by injecting dry compressed air through the ventilation louvers.



#### DANGER

Improper handling of compressed air can be hazardous and cause bodily injury and property damage. Wear protective glasses to prevent eye injuries. When using compressed air make sure to strictly observe the applicable regulations.

The compressed air must meet the following specifications:

- free of oil and moisture
- free of particles (>5 µm)
- overpressure 4 ... 8 bar

### 9.3 Maintenance

The unit requires no special maintenance except for the above cleaning work. For maintenance of the gauges, please consult the corresponding documents (→  [1] ... [15]).

## 10 Accessories and Spare Parts

When ordering accessories and spare parts, always mention:

- all information on the product nameplate
- description and ordering number according to the list

### Sensor cables

	Ordering number
Sensor cable for connection to compact gauge	
3 meters, complete	PT 448 250 -T
6 meters, complete	PT 448 251 -T
10 meters, complete	PT 448 252 -T
Other cable lengths on request	

### Cable elements

	Ordering number
Pos. 1 Cable, 5 conductors plus shielding, conductor 0.25 mm <sup>2</sup>	B 4590 198 BD
Cable, 5 conductors plus shielding, conductor 0.34 mm <sup>2</sup>	B 4590 198 CD
Pos. 6 Hirschmann line socket GO 6 WF, 6-pin, angular, female	B 4707 283 MA
Pos. 7 Connector Amphenol C91B, 6-pin, male	B 4722 126 CC
Pos. 8 Crimp contact (6 pieces required)	B 4722 841 CA

Figure 68:  
Cable elements

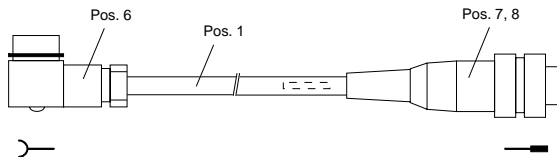

### Rack accessories

	Ordering number
Blank panel for 19" frame 2 height units, ½ rack	PT 441 481
Connection piece MaxiGauge™-blank panel	PT 441 480 -T
Adapter for 19", 3 height units, 63 length units, ¾ rack	PT 441 248 -X



Other articles

	Ordering number
Acrylic glass stand for bench top unit	PT 441 483
IF 256 RS485/422 interface (retrofit set)	PT 441 240 -T
RI 256 Relay interface	PT 441 490 -T
GS 250 Compact Gauge simulator	PT 583 066 -T

Figure 69:  
Acrylic glass stand

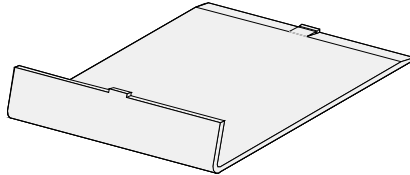

## 11 Decommissioning

The owner is responsible for the disposal of the unit.  
He shall

- either return it, freight prepaid, to a Pfeiffer Vacuum Service Center
- or give it to a licensed, public or private disposal company
- or reuse, recycle, or dispose of it in conformance with the applicable laws

If the owner disposes of the unit himself, he shall observe the laws and regulations applicable in the corresponding country (in the EEC, such disposal is governed by EC guideline 75/442/EEC). A copy of the applicable laws can be obtained from the competent authorities.

Waste material has to be reused, recycled, or disposed of in such a way, that

- human health is not endangered
- no processes and methods threatening the environment – especially the water, the air, the soil, the fauna and the flora – are used
- no offensive noises or odors are produced
- the appearance of the environment is not impaired



### **DANGER**

When proceeding to decommission the unit, observe that some of the electronic modules are alive (mains voltage). Unplug therefore the power connector before opening the unit (danger of electric shock).

## Appendix

### A: Validity Table

Parameter	Gauge					
	logarithmic					linear
	TPR PCR	IKR	PKR	IMR	PBR	APR CMR ACR

#### Measurement Mode

Sen-On/ Sen-off		✓	✓	✓	✓	

#### Setpoint Mode

Control Sensor	✓	✓	✓	✓	✓	✓
SetPoint high	✓	✓	✓	✓	✓	✓
SetPoint low	✓	✓	✓	✓	✓	✓
UR-Control		✓				

#### Sensor Parameter Mode

Type (Range)						✓
Offset						✓
Degas					✓	
Cal-Factor	✓	✓	✓	✓ <sup>*)</sup>	✓ <sup>*)</sup>	✓
Filter	✓	✓	✓	✓	✓	✓
Name	✓	✓	✓	✓	✓	✓

#### Sensor Control Mode

Control		✓	✓	✓	✓	
On		✓	✓	✓	✓	
Off		✓	✓	✓	✓	
On Threshold		✓		✓	✓	
Off Threshold		✓		✓	✓	

<sup>\*)</sup> Available for the hot cathode measurement range only.

## B: Conversion of Pressure Units

	bar	mbar	μbar	Pa	kPa	Torr	mTorr <sup>*)</sup>	psi
bar	1	10 <sup>3</sup>	10 <sup>6</sup>	10 <sup>5</sup>	10 <sup>2</sup>	750	750×10 <sup>3</sup>	14.5
mbar	10 <sup>-3</sup>	1	10 <sup>3</sup>	10 <sup>2</sup>	0.1	0.75	750	14.5×10 <sup>-3</sup>
μbar	10 <sup>-6</sup>	10 <sup>-3</sup>	1	0.1	10 <sup>-4</sup>	7.5×10 <sup>-4</sup>	0.75	14.5×10 <sup>-6</sup>
Pa	10 <sup>-5</sup>	10 <sup>-2</sup>	10	1	10 <sup>-3</sup>	7.5×10 <sup>-3</sup>	7.5	14.5×10 <sup>-5</sup>
kPa	10 <sup>-2</sup>	10	10 <sup>4</sup>	10 <sup>3</sup>	1	7.5	7.5×10 <sup>3</sup>	14.5×10 <sup>-2</sup>
Torr	1.33×10 <sup>-3</sup>	1.33	1.33×10 <sup>3</sup>	133	0.133	1	1000	19.3×10 <sup>-3</sup>
mTorr	1.33×10 <sup>-6</sup>	1.33×10 <sup>-3</sup>	1.33	0.133	1.33×10 <sup>-4</sup>	10 <sup>-3</sup>	1	19.3×10 <sup>-6</sup>
psi	6.89×10 <sup>-2</sup>	68.9	68.9×10 <sup>3</sup>	6890	6.89	51.7	51.7×10 <sup>3</sup>	1

\*) mTorr = micron = μ

## C: Equipment Test



**Specialists**

The unit may only be tested by persons skilled and trained for this work.

Access to the «Test» mode is only possible by pressing the [Mode] softkey if a key was held down during the power on process.

(→ Overview «Test» mode  34).

Figure 70:  
«Test» display



Running the test routine:

- Select the «Test» mode (if applicable) (→  39)
- Press the [next.] softkey to select the desired test program
- By briefly pressing the [Start.] softkey, the program is started; it is aborted (if required) by briefly pressing the [Return] softkey

If any problem arises, please contact your nearest Pfeiffer Vacuum Service Center. Any interventions inside the unit require special skills and training and may lead to a revocation of the warranty.

### Program

The cursor cannot go to the first line «Program». It displays the current firmware (software) version. Its last digit stands for the index: «-» or «A... Z». This information is always useful when contacting Pfeiffer Vacuum in case of a fault.

### RAM

Test of the data memory. The test is run automatically («busy» is displayed). If the test has been successful, «Passed», if not, «error» is displayed. If the test has not been successful, an error message flashes in the middle softkey display bar.

### EPROM, EEPROM

Test of the program and the parameter memory. The test is run automatically («busy» is displayed). If the test has been successful, «Passed», if not, «error» is displayed. If the test has not been successful, an error message flashes in the middle softkey display bar.

In addition, the check sum is displayed.

## Display

Test of the RAM display memory. The test is run automatically («busy» is displayed). The contrast changes progressively to bright and dark twice. If the test has been successful, «Passed», if not, «error» is displayed. If the test has not been successful, an error message flashes in the middle softkey display bar.

## A/D

Test of the analog/digital converters (for the display format). The left column shows the signals of the six connected gauges measured at the A/D converter. The opposite values in the right column show the corresponding identification voltages, equally measured at the A/D converter.



### NOTE

If no gauges are connected, the unit displays default values that may easily fluctuate because of the high sensitivity of the open measurement circuits.

## I/O (automatic)

Test of all unit relays (change of display). The «I/O» test routine checks the corresponding switching functions: The relays are cyclically switched on and off twice. Only the relays designated with «switch» and «error» are relevant for the user. The corresponding contacts are conducted to the *relay* connector on the back of the unit (→  22).

The switching operations are optically indicated and can be heard. Check the switching contacts of the relays with an ohmmeter.



### DANGER

The relays switch over independently of the pressure! Make sure that no control signals or messages are triggered by mistake. Unplug any connected sensor or control cables.

## I/O (manual)

A relay function can also be tested manually (see «I/O automatic»):

- Press the [next] softkey to select the «I/O» parameter
- Press the [Relay] softkey to interrupt the automatic test routine and select a particular relay by repeatedly briefly pressing the [Relay] softkey
- Press the [▲] softkey to activate the selected relay and the [▼] to deactivate it
- Press the [Relay] to select the next relay, activate and deactivate it as described above
- Press the [Return] softkey to return to the «Test» mode

## Interface

Test of the receiver/transmitter buffers. The data transfer from/to the interfaces can be monitored.







## WDT-Ctrl

This parameter allows to set the system control (watchdog control) to automatic or manual.







In automatic mode, a watchdog-error message is automatically acknowledged after two seconds whereas in manual mode, it has to be acknowledged by pressing the corresponding softkey.

- Press the [▲] or [▼] softkey to set the parameter value to «aut.» (default) or «hand»
- Press the [Return] softkey to return to the «Measurement» mode

## D: Literature

- [1]  [www.pfeiffer-vacuum.net](http://www.pfeiffer-vacuum.net)  
Operating manual  
Compact Pirani Gauge TPR 261  
BG 805 175 BE  
Pfeiffer Vacuum GmbH, D-35614 Asslar,  
Deutschland
  
- [2]  [www.pfeiffer-vacuum.net](http://www.pfeiffer-vacuum.net)  
Operating manual  
Compact Pirani Gauge TPR 265  
BG 805 174 BE  
Pfeiffer Vacuum GmbH, D-35614 Asslar,  
Deutschland
  
- [3]  [www.pfeiffer-vacuum.net](http://www.pfeiffer-vacuum.net)  
Operating manual  
Compact Pirani Gauge TPR 280  
BG 805 178 BE  
Pfeiffer Vacuum GmbH, D-35614 Asslar,  
Deutschland
  
- [4]  [www.pfeiffer-vacuum.net](http://www.pfeiffer-vacuum.net)  
Operating manual  
Compact Pirani Gauge TPR 281  
BG 5179 BE  
Pfeiffer Vacuum GmbH, D-35614 Asslar,  
Deutschland
  
- [5]  [www.pfeiffer-vacuum.net](http://www.pfeiffer-vacuum.net)  
Operating manual  
Compact Pirani Capacitance Gauge PCR 260  
BG 805 180 BE  
Pfeiffer Vacuum GmbH, D-35614 Asslar,  
Deutschland
  
- [6]  [www.pfeiffer-vacuum.net](http://www.pfeiffer-vacuum.net)  
Operating manual  
Compact Cold Cathode Gauge IKR 251  
BG 803 151 BE  
Pfeiffer Vacuum GmbH, D-35614 Asslar,  
Deutschland
  
- [7]  [www.pfeiffer-vacuum.net](http://www.pfeiffer-vacuum.net)  
Operating manual  
Compact Cold Cathode Gauge IKR 261  
BG 805 153 BE  
Pfeiffer Vacuum GmbH, D-35614 Asslar,  
Deutschland



-  [8] [www.pfeiffer-vacuum.net](http://www.pfeiffer-vacuum.net)  
 Operating manual  
 Compact Cold Cathode Gauge IKR 270  
 BG 805 008 BE  
 Pfeiffer Vacuum GmbH, D-35614 Asslar,  
 Deutschland
-  [9] [www.pfeiffer-vacuum.net](http://www.pfeiffer-vacuum.net)  
 Operating manual  
 Compact FullRange™ Gauge PKR 251  
 BG 805 155 BE  
 Pfeiffer Vacuum GmbH, D-35614 Asslar,  
 Deutschland
-  [10] [www.pfeiffer-vacuum.net](http://www.pfeiffer-vacuum.net)  
 Operating manual  
 Compact FullRange™ CC Gauge PKR 261  
 BG 805 157 BE  
 Pfeiffer Vacuum GmbH, D-35614 Asslar,  
 Deutschland
-  [11] [www.pfeiffer-vacuum.net](http://www.pfeiffer-vacuum.net)  
 Operating manual  
 Compact Process Ion Gauge IMR 260  
 BG 805 038 BE  
 Pfeiffer Vacuum GmbH, D-35614 Asslar,  
 Deutschland
-  [12] [www.pfeiffer-vacuum.net](http://www.pfeiffer-vacuum.net)  
 Operating manual  
 Compact Ion Gauge IMR 265  
 BG 805 172 BE  
 Pfeiffer Vacuum GmbH, D-35614 Asslar,  
 Deutschland
-  [13] [www.pfeiffer-vacuum.net](http://www.pfeiffer-vacuum.net)  
 Operating manual  
 Compact FullRange™ BA Gauge PBR 260  
 BG 805 171 BE  
 Pfeiffer Vacuum GmbH, D-35614 Asslar,  
 Deutschland
-  [14] [www.pfeiffer-vacuum.net](http://www.pfeiffer-vacuum.net)  
 Operating manual  
 Compact Capacitance Gauge CMR 261,  
 CMR 262, CMR 263, CMR 264, CMR 271,  
 CMR 272, CMR 273, CMR 274, CMR 275  
 BG 805 161 BE  
 Pfeiffer Vacuum GmbH, D-35614 Asslar,  
 Deutschland

 [15] [www.pfeiffer-vacuum.net](http://www.pfeiffer-vacuum.net)  
Operating manual  
Compact Piezo Gauge APR 250, APR 260,  
APR 262, APR 265, APR 266, APR 267  
BG 805 035 BE  
Pfeiffer Vacuum GmbH, D-35614 Asslar,  
Deutschland

**Declaration of Conformity**

Product

**TPG 256 A**

Vacuum measurement and control unit  
for Compact Gauges

**MaxiGauge™**

EU Declaration of Conformity  
as defined by the listed  
Guidelines

We herewith declare that the above product complies  
with the provisions of the listed Guidelines.

Guidelines, harmonised standards, national standards in  
languages and specifications which have been applied:

89/336/EEC (7/93) .....

73/23/EEC (7/93) .....

98/68/EEC (7/93) .....

EN 61010-1, EN 60950: 1993 .....

EN 50081-1: 1992 .....

EN 50082-2: 1995 .....

Signature

Asslar, 8 July 1999



Wolfgang Dondorf  
Managing Director

**PFEIFFER**  **VACUUM**

*Berliner Strasse 43*

*D-35614 Asslar*

*Deutschland*

*Tel +49 (0) 6441 802-0*

*Fax +49 (0) 6441 802-202*

*info@pfeiffer-vacuum.de*

*[www.pfeiffer-vacuum.net](http://www.pfeiffer-vacuum.net)*

*Original: German BG 805 186 BD / B (2005-07)*



bg805186be/ b