

# A Cryogenic Low-noise JFET-CMOS Preamplifier for the HPGe Detectors of GERDA

A. Pullia, F. Zocca, S. Riboldi, D. Budjáš, A. D'Andragora, C. Cattadori

**Abstract** -- Cryogenic low-noise charge sensitive preamplifiers have been realized and tested for the GERmanium Detector Array (GERDA). In the search of neutrino-less double-beta decay of  $^{76}\text{Ge}$  at LNGS, GERDA will operate bare segmented germanium detectors immersed in liquid argon. The front-end electronics will operate in the cryogenic liquid too. An integrated JFET-CMOS preamplifier, which is fully functional at cryogenic temperatures, has been developed and realized. It has been tested in conjunction with an unsegmented p-type HPGe detector. Both the crystal and the preamplifier were operated inside a liquid nitrogen dewar at 77 K. The detector capacitance was  $\sim 60$  pF. An optimum resolution of 1.6 keV fwhm was obtained on the pulser line at 6  $\mu\text{s}$  shaping time. The obtained resolution for the 1.332 MeV line from a  $^{60}\text{Co}$  source was of 2.2 keV fwhm. No peak shifts or line broadenings were seen during long-term acquisitions, thanks also to the extremely high preamplifier loop gain which yields a very high closed-loop gain stability. A wide bandwidth (rise time of 16 ns) permits use of pulse-shape analysis techniques to localize the position of the photon interactions inside the detector. A low power consumption (23.4 mW) makes the preamplifier suitable for the foreseen multi-channel array of germanium detectors.

## I. INTRODUCTION

Use of segmented High-Purity Germanium (HPGe) detectors is foreseen in the GERDA experiment (GERmanium Detector Array) [1,2] in the search of neutrino-less double-beta decay of  $^{76}\text{Ge}$ . Bare germanium detectors, isotopically enriched in  $^{76}\text{Ge}$ , will be operated in liquid argon. The cryogenic liquid is used both as a cooling medium and as a shield against external radiation. The numerous requirements for the front-end electronics include a high degree of radio purity and the full functionality when immersed in liquid argon. Some different solutions have been studied for the read-

out of the GERDA crystals [3,4]. In particular a CMOS low-noise charge preamplifier has been developed, realized and tested. In this work the very good performances obtained are described. The circuit has been tested when coupled to an unsegmented coaxial HPGe crystal. Both the detector and the preamplifier were immersed in a liquid nitrogen dewar and operated at 77 K. The preamplifier performances obtained fully meet the challenging requirements for the GERDA experiment: functionality at cryogenic temperatures, low noise, low power consumption, rise time  $< 20$  ns, large negative output voltage swing, high closed-loop gain stability.

## II. DETECTOR SETUP AND CHARGE-PREAMPLIFIER STRUCTURE

In Fig.1 the experimental setup developed at MPI-Heidelberg [1] is shown. An unsegmented p-type coaxial closed-end HPGe crystal is encapsulated in a standard silicon holder and operated in a vacuum chamber (Fig. 1a). The crystal has a diameter of 5.2 cm and an height of 5.1 cm. A plate for the mounting of the front-end electronics is placed below the vacuum chamber at a distance of  $\sim 5$  cm (Fig. 1a). Both the chamber and the plate are supported by a steel frame (Fig. 1b) so as to be directly immersed in a liquid nitrogen dewar (Fig. 1c). The germanium crystal is thermally connected to the cryostat (Fig. 1a) and therefore operated at 77 K as well as the front-end electronics. The detector outer contact is biased at the high voltage of 2.5 kV. The inner electrode is the read-out electrode and it is DC-coupled to the preamplifier. As the read-out electrode receives holes, the signal polarity is negative.

In Figs. 2 and 3 the realized charge-sensitive preamplifier is shown. It is optimized for negative output voltage swings and has the circuit structure shown in Fig. 2. It consists of an external low-noise silicon JFET (Junction Field Effect Transistor) manufactured by Philips, mod. BF862, an external feedback network ( $C_F = 0.2$  pF,  $R_F = 1.2$  G $\Omega$ ), and an ASIC (Application Specific Integrated Circuit) used as low-noise operational amplifier along the negative-feedback loop. The ASIC has been realized in a 5V 0.8  $\mu\text{m}$  silicon CMOS technology and it is equipped with a low-output-impedance output stage able to drive a fully terminated coaxial cable and to provide at the same time a large negative voltage swing,

---

A. Pullia, F. Zocca and S. Riboldi are with the University of Milano, Department of Physics and INFN-Sezione di Milano, Milano, Italy.

D. Budjáš is with MPI, Heidelberg, Germany.

A. D'Andragora is with INFN-LNGS, L'Aquila, Italy.

C. Cattadori is with INFN-Sezione di Milano-Bicocca, Milano, Italy and with INFN-LNGS, L'Aquila, Italy.

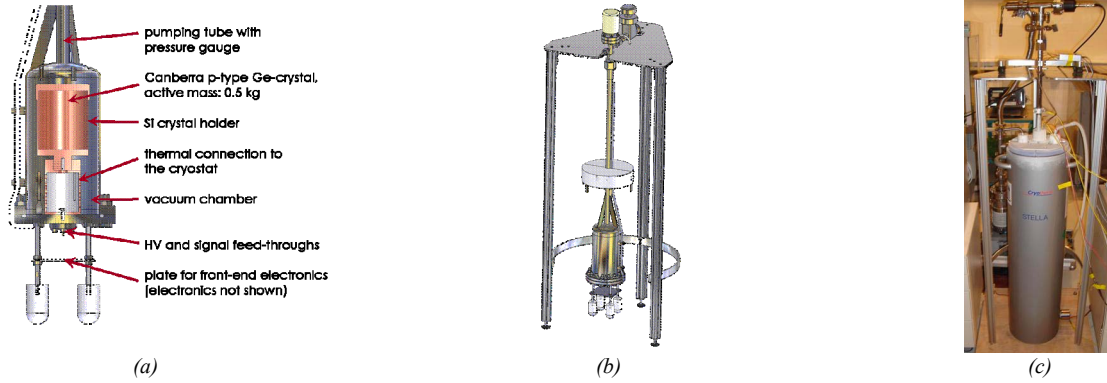

Fig. 1. Detector experimental set-up. (a) Vacuum chamber containing the encapsulated HPGe crystal. A plate for the mounting of the front-end electronics is placed below the chamber. (b) Steel frame supporting the vacuum chamber and the front-end electronics. (c) Liquid nitrogen dewar where the vacuum chamber and the front-end electronics are immersed and operated at 77 K.

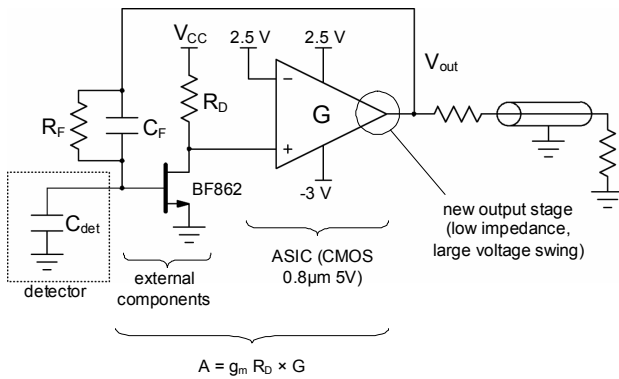

Fig. 2. Charge sensitive preamplifier structure, consisting of an external JFET, an external feedback network, and an ASIC used as low-noise operational amplifier along the negative-feedback loop.

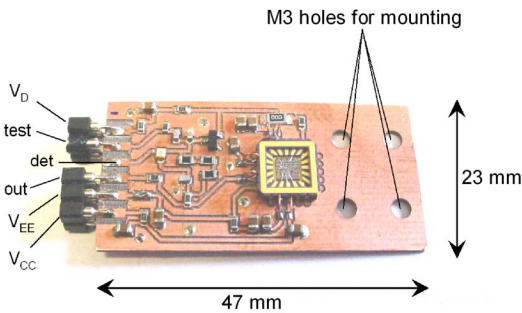

Fig. 3. Picture of the realized JFET-CMOS preamplifier as mounted on a PCB of 0.8 mm teflon laminate. The ASIC is realized in a 5V 0.8 $\mu$ m silicon CMOS technology.

close to the negative power supply. The tested JFET-CMOS preamplifier is shown in Fig. 3. The discrete input devices as well as the integrated circuit are mounted on a PCB of 0.8 mm PTFE (teflon) laminate. The design of an integrated preamplifier for high-resolution gamma-ray spectroscopy is

particularly challenging. A large dynamic range of at least 60 dB is required, with the lower and lower available voltage swing of scaled CMOS technologies. Moreover, a long-term gain stability better than 0.2% and a high integral linearity over the full range are required. The output stage is a very critical part as the signal is to be transmitted to a remote receiver through a long terminated coaxial cable. The output stage has to provide a considerable power in the shortest possible time and it should be able to provide a rail-to-rail output voltage swing. A standard high output impedance solution is not adequate for the present application as it makes the preamplifier loop gain highly dependent on the value of the output load resistor. A low output impedance solution, optimized for negative signals (holes) has been realized, consisting of a self-adjusting constant current NMOS source-follower. The current load is provided by a second NMOS transistor acting as a driver. The measured output voltage saturates at -2.5 V against a negative power supply of -2.7 V.

### III. TEST-BENCH CHARACTERIZATION OF THE PREAMPLIFIER AT T=300 K AND T=77 K

We characterized the preamplifier at the test bench by simulating the detector with a capacitance and by injecting fast test pulses at the input node through a 1 pF test capacitance. We measured the characteristic curves of the input BF862 JFET when the device was operated at room temperature and when it was operated in liquid nitrogen (77 K). The results are shown in the Figs. 4 and 5. The characteristic curves of the input JFET substantially change when the temperature is decreased from 300 K to 77 K, as the device starts suffering of freeze-out phenomena. For given values of the gate-to-source and gate-to-drain voltages, the drain current decreases by a factor of 5. The changed bias point at cryogenic temperature yields the advantage of a drop in the power consumption. At room temperature the power supply used for the external JFET

is of 12 V and the drain current is of 14 mA, so yielding a power consumption of 168 mW. At 77 K the power supply used is of 4V and the drain current is of 3 mA, so yielding a power consumption of only 12 mW. On the other hand, the changed JFET bias point determines a drop in the JFET transconductance, that can affect the noise and bandwidth performances.

As far as noise is concerned, we measured the Equivalent Noise Charge (ENC) of the circuit as a function of the shaping time, while simulating the detector with a capacitance of 15 pF, as shown in Fig. 6. The decreased temperature only partially compensates the effect of a decreased transconductance, so that the overall white noise is higher at 77 K than at room temperature. Anyway, at a shaping time of 10  $\mu$ s, the ENC achieves the same value both at room and at cryogenic temperature, or  $\sim 112$  electrons r.m.s. (corresponding to 0.77 keV fwhm in HPGe). So the noise performance remains fully compatible with gamma-ray spectroscopy requirements.

As far as bandwidth is concerned, the drops in the JFET transconductance at 77 K was expected to determine a drop in

the preamplifier bandwidth too. We experimentally found the opposite result: the preamplifier bandwidth increased when the circuit was operated at cryogenic temperature. The reason can be found in the behavior of the transconductance of the MOSFET transistors when operated at 77 K. The MOSFET's transconductance definitely increases while temperature decreases. This effect overcomes the effect due to the decrease of the JFET transconductance. The higher gain of the ASIC

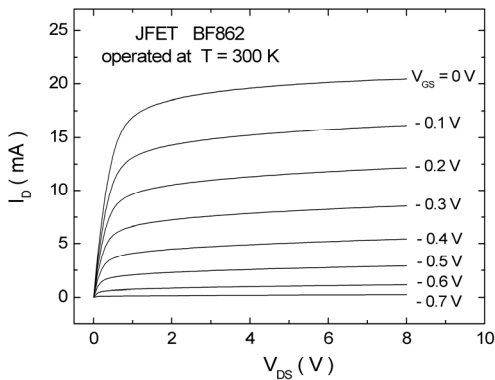

Fig. 4. Characteristic curves of the input JFET BF862 as measured when the device is operated at room temperature.

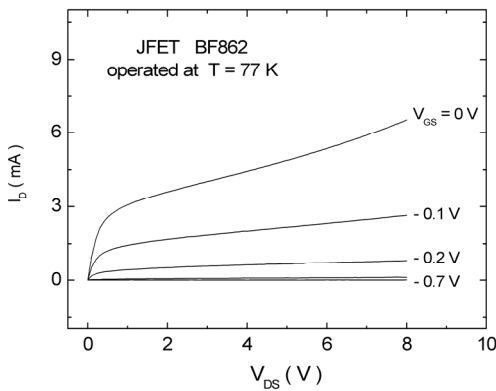

Fig. 5. Characteristic curves of the input JFET BF862 as measured when the device is operated at 77 K while immersed in liquid nitrogen. The drain current decreases by a factor of 5, yielding a substantial drop in the transconductance value.

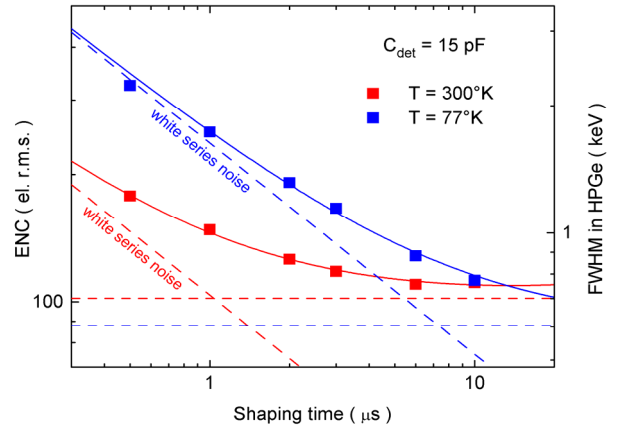

Fig. 6. Noise of the preamplifier as measured at the test bench at 300 K and 77 K at different shaping times.

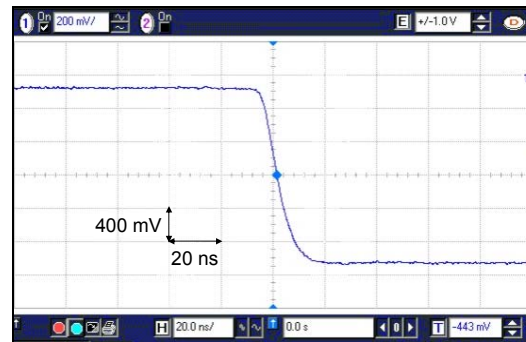

Fig. 7. Preamplifier response to a fast input pulse at 300 K. The transition time is as fast as 13 ns. The detector capacitance is 15 pF. The Miller compensation capacitance inside the ASIC is 0.6 pF.

TABLE I  
RISE TIME OBTAINED AT THE TEST BECH WITH DIFFERENT VALUES OF THE DETECTOR CAPACITANCE (ASIC MILLER CAPACITANCE OF 1pF)

| $C_{DET}$ | T = 300 K | T = 77 K          |
|-----------|-----------|-------------------|
| 0 pF      | 14 ns     | 7 ns (ringing)    |
| 22 pF     | 21 ns     | 12 ns (overshoot) |
| 33 pF     | 26 ns     | 13 ns             |
| 56 pF     | 34 ns     | 18 ns             |
| 100 pF    | 50 ns     | 28 ns             |

amplifier at 77 K determines a higher loop gain of the overall preamplifier and a consequent wider bandwidth. While injecting a fast test pulse at the preamplifier input, we could measure a rise time of 13 ns in the preamplifier response at room temperature, as shown in Fig. 7. When the circuit was in liquid nitrogen the rise time was much faster but the output response showed some ringing. In order to get a fast but stable circuit response at cryogenic temperature, we had to decrease the preamplifier bandwidth, by increasing the value of the Miller compensation capacitance inside the ASIC amplifier, from a value of 0.6 pF to 1 pF. In Table I the obtained rise time values are shown as measured at 300 K and 77 K with a 1 pF Miller capacitance. Note that the preamplifier bandwidth has been optimized in order to get a fast and stable response at 77 K with the highest expected values of the detector capacitance, at the expenses of a decreased bandwidth at room temperature.

#### IV. EXPERIMENTAL MEASUREMENTS WITH THE DETECTOR SETUP: PREAMPLIFIER PERFORMANCES AND ENERGY RESOLUTIONS

We then tested the preamplifier with the detector experimental setup described in Section II (see Fig. 1). In Figs. 8-12 some of the very good results obtained are shown. In Fig. 8 the preamplifier output response to a fast input test pulse is shown, when the circuit is connected to the detector and it is driving a  $\sim 10$  m terminated coaxial output cable. A very clean leading edge is obtained with a transition time as fast as 16 ns. In Fig. 9 the leading edge of a signal from a  $^{60}\text{Co}$  radioactive source is shown. Thanks to the wide preamplifier bandwidth, the shape of the leading edge is very well identified and permits application of pulse-shape analysis algorithms to localize the position of the photon interactions inside the detector. In Fig. 10 the preamplifier output signal is shown in a longer time scale when a  $^{60}\text{Co}$  source is irradiating the detector. Note that the time constant of the baseline recovery is  $\sim 250$   $\mu\text{s}$ . We tested the energy resolution while connecting the preamplifier output to a quasi-Gaussian shaper amplifier and a pulse height analyzer. In Fig. 11 the obtained energy resolution

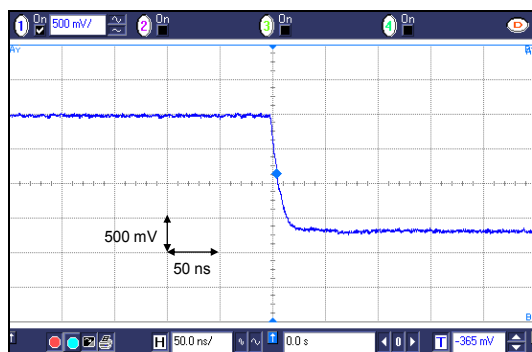

Fig. 8. Preamplifier output response to a fast input test pulse. The circuit is connected to the detector and operated at 77 K. A  $\sim 10$  m terminated coaxial cable is connected at the output. The transition time is as fast as 16 ns.

is shown as a function of the shaping time for a pulser line and for the 1.332 MeV  $^{60}\text{Co}$  line. An optimum resolution of 1.6 keV fwhm is obtained for the pulser line at 6  $\mu\text{s}$  shaping time. The 1.332 MeV  $^{60}\text{Co}$  line typically shows a resolution of

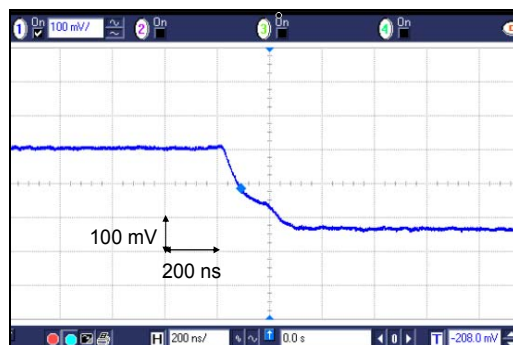

Fig. 9. Scope trace of a signal from a  $^{60}\text{Co}$  radioactive source. The shape of the leading edge is well identified and permits application of pulse shape analysis algorithms.

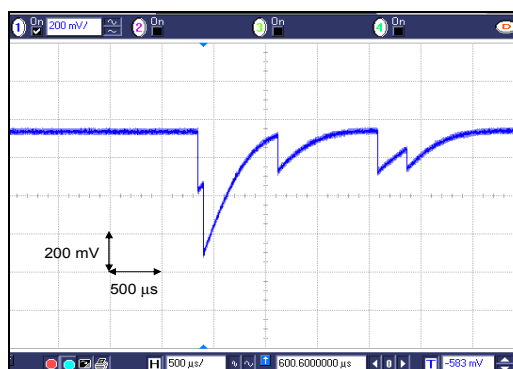

Fig. 10. Scope trace of a preamplifier output signal in the presence of a  $^{60}\text{Co}$  source. The time constant of the baseline recovery is about 250  $\mu\text{s}$ .

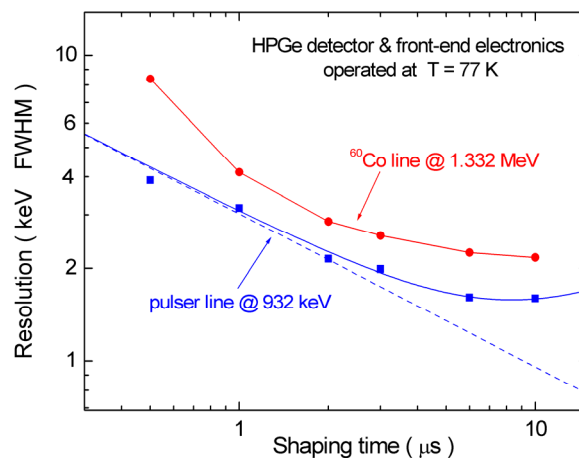

Fig. 11. Energy resolution as a function of the shaping time. The optimum resolution of 1.6 keV fwhm is obtained for the pulser line at 6  $\mu\text{s}$  shaping time. The detector capacitance is  $\sim 60$  pF.

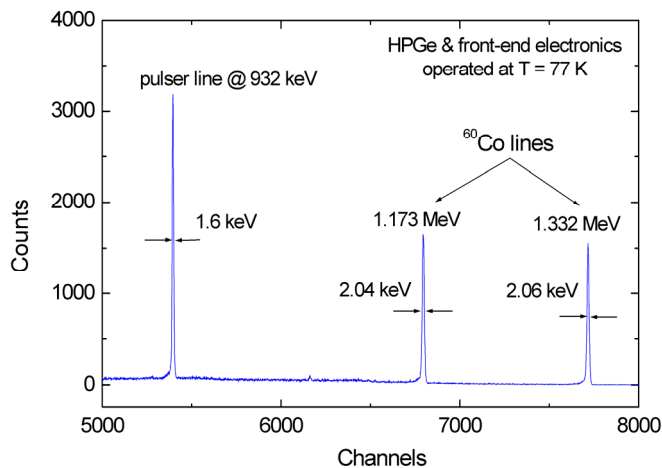

Fig. 12. Spectrum collected in the presence of a  $^{60}\text{Co}$  source. A resolution of 2.04 and 2.06 keV fwhm has been obtained for the two  $^{60}\text{Co}$  lines.

2.25 keV fwhm at 6  $\mu\text{s}$  and of 2.17 keV fwhm at 10  $\mu\text{s}$ . Note that the detector capacitance is  $\sim 60$  pF. The best collected  $^{60}\text{Co}$  spectrum is shown in Fig. 12, where a very good resolution of 2.04 and 2.06 keV fwhm has been achieved for the  $^{60}\text{Co}$  lines. No peak shift has been seen in long-term acquisitions. Background spectra collected over night showed a resolution of 1.6-1.7 keV fwhm for the lines at the lowest energies. This limit in the achievable resolution corresponds to the electronic noise contribution. No line broadening could be seen. This also indirectly confirms the very large value of the preamplifier loop gain and consequently the very good closed-loop gain stability. The preamplifier specifications are summarized in Table II. The negative output voltage swing is  $\sim 2.5$  V, with a negative power supply of  $-2.7$  V. As the preamplifier sensitivity is  $\sim 290$  mV/MeV (not terminated), the input dynamic energy range is  $\sim 8.6$  MeV. The measured power consumption of the preamplifier is only 23.4 mW. This is particularly important for the future GERDA multi-channel array of germanium detectors, where a high count of read-out channels inside the cryogenic liquid is foreseen.

## V. CONCLUSIONS

A low-noise JFET-CMOS charge preamplifier for HPGe detectors has been developed and realized in the framework of the GERDA experiment. The circuit is fully functional both at room and cryogenic temperature and meets the requirements of high-resolution gamma-ray spectroscopy with germanium detectors. It has been tested in conjunction with an unsegmented p-type HPGe detector. Both the crystal and the

TABLE II  
PREAMPLIFIER SPECIFICATIONS

|   |   |
|---|---|
| Working temperature                                     | from $-196^\circ\text{C}$ to $55^\circ\text{C}$<br>(from 77 K to 328 K)                                 |
| Negative output voltage swing on 150 $\Omega$ impedance | $\sim 2.5$ V (against a negative power supply of $-2.7$ V)  |
| Energy sensitivity ( $C_F = 0.2$ pF)                    | $\sim 290$ mV/MeV at preamp output<br>$\sim 217$ mV/MeV after 150 $\Omega$ termination                  |
| Input dynamic range                                     | $\sim 8.6$ MeV  |
| Rise time   | $\sim 16$ ns with $\sim 10$ m terminated coaxial cable  |
| Fall time   | $\sim 250$ $\mu\text{s}$ ( $R_F = 1.2$ G $\Omega$ )   |
| Open-loop gain  | $\sim 3.5 \cdot 10^5$   |
| Loop gain   | $\sim 600$  |
| Resolution at T= 77 K ( $\tau = 6\mu\text{s}$ )         | 2.2 keV @ 1.332 MeV ( $^{60}\text{Co}$ )<br>1.6 keV @ 932 keV pulser line                               |
| Power required at T=77K                                 | 23.4 mW<br>( $V_{\text{FET}} = +4$ V $I_D = 3$ mA<br>$V_{\text{CC}} = +3.6$ V $V_{\text{EE}} = -2.8$ V) |

preamplifier were operated inside a liquid nitrogen dewar at 77 K. The detector capacitance was  $\sim 60$  pF. An optimum resolution of 1.6 keV fwhm was obtained on the pulser line at 6  $\mu\text{s}$  shaping time. The 1.332 MeV line from a  $^{60}\text{Co}$  source showed a resolution of 2.2 keV fwhm. A wide bandwidth (rise time of  $\sim 16$  ns) and a low power consumption ( $\sim 23$  mW) make the preamplifier suitable for the future GERDA multi-channel array of germanium detectors, where pulse-shape analysis techniques may be applied in order to localize the interaction positions of the gamma-photons inside the crystals.

## VI. REFERENCES

- [1] Web site (GERDA home page): <http://www.mpi-hd.mpg.de/ge76/>
- [2] S. Schonert, I. Abt, M. Altmann, A. M. Bakalyarov, I. Barabanov, C. Bauer, et al., "GERDA: A new  $^{76}\text{Ge}$  Double Beta Decay Experiment at Gran Sasso", Nucl. Physics B Suppl., vol. 143, pp. 567-567, June 2005
- [3] A. Pullia, F. Zocca, C. Cattadori, "Low-noise amplification of  $\gamma$ -ray detector signals in hostile environments", IEEE Trans. Nucl. Sci., vol. 53, no. 3, pp. 1744-1748, June 2006.
- [4] C. Cattadori, O. Chkvorets, M. Junker, K. Kroeninger, L. Pandola, A. Pullia, V. Re, C. Tomei, C. Ur and F. Zocca, "The GERMANium Detector Array read-out: status and developments", Nucl. Instrum. Methods Phys. Res. A, vol. A572, pp. 479-480, March 2007.