

Scanning of the RG I detector by the collimated gamma sources ^{133}Ba and ^{152}Eu .

M. Barnabe-Heider (MPIK), O. Chkvorets (MPIK),
E. Demidova (ITEP), K. Gusev (RRC 'KI'),
M. Junker (LNGS), I. Kirpichnikov (ITEP),
A. Klimenko (JINR), S. Schoenert (MPIK),
A. Smolnikov (JINR), A. Vasenko (ITEP),
S. Vasiliev (JINR).

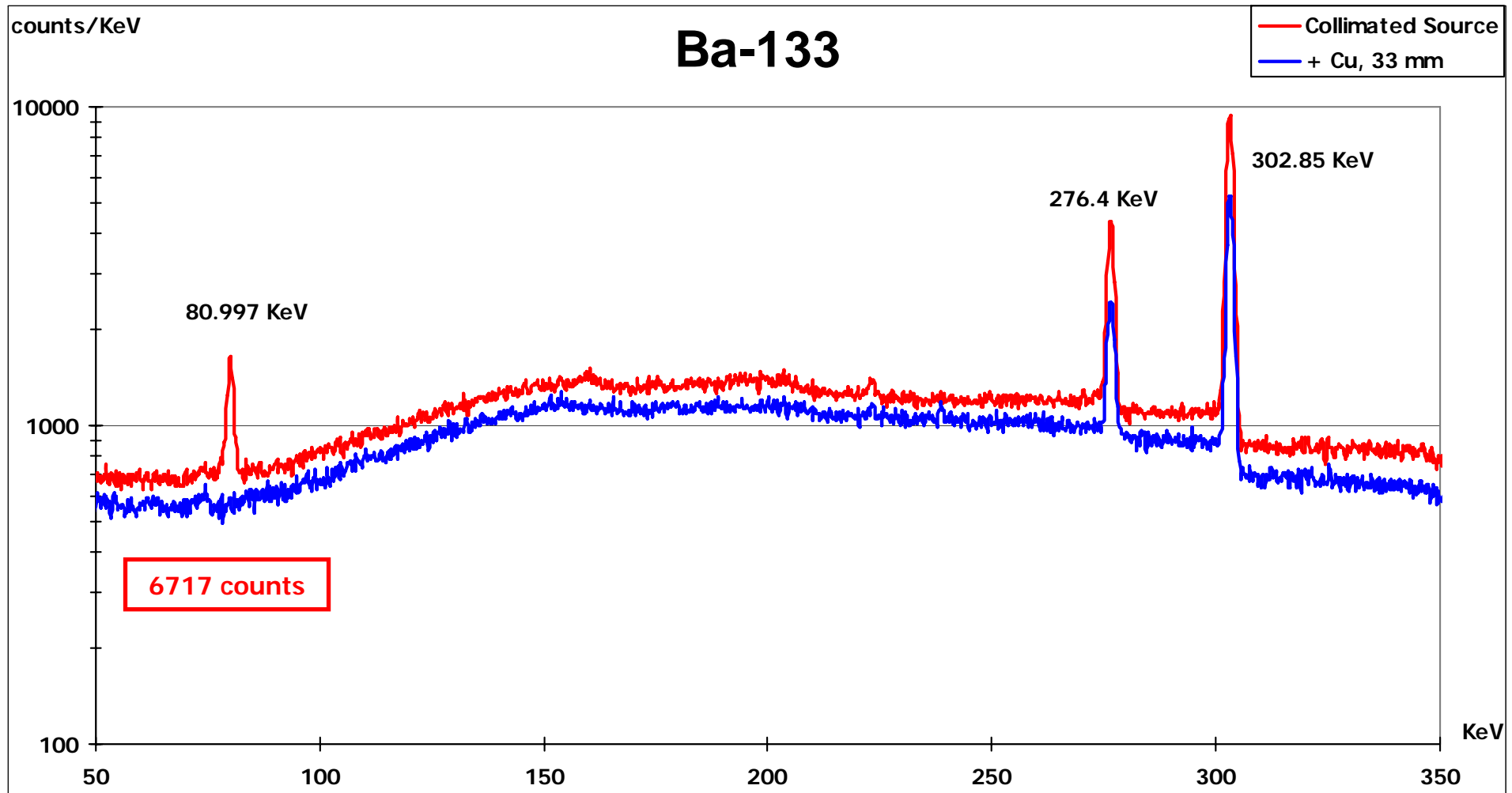

Figure 1: Spectra of collimated ^{133}Ba , $t = 900$ sec

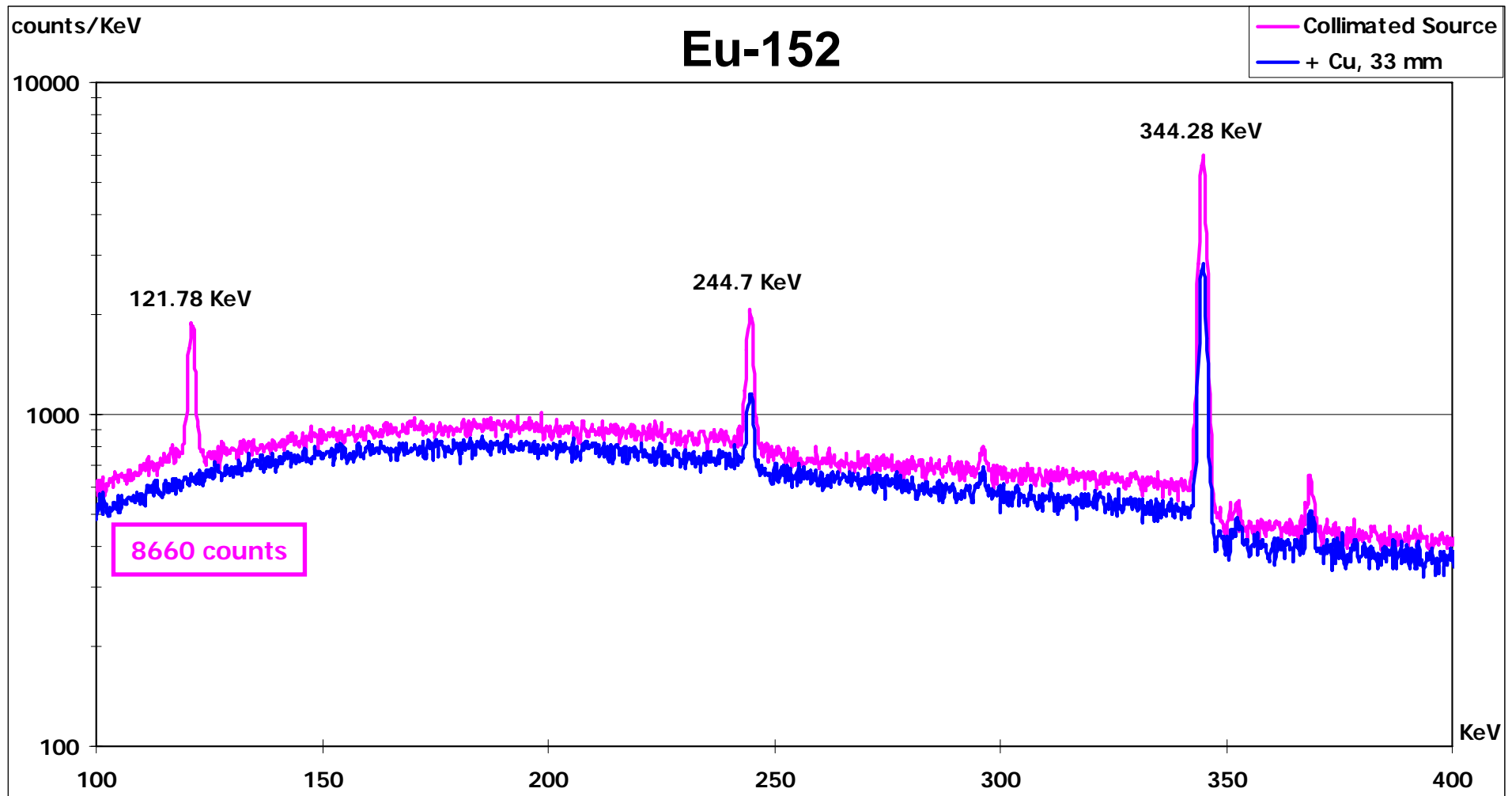

Figure 2: Spectra of collimated ^{152}Eu , $t = 900$ sec

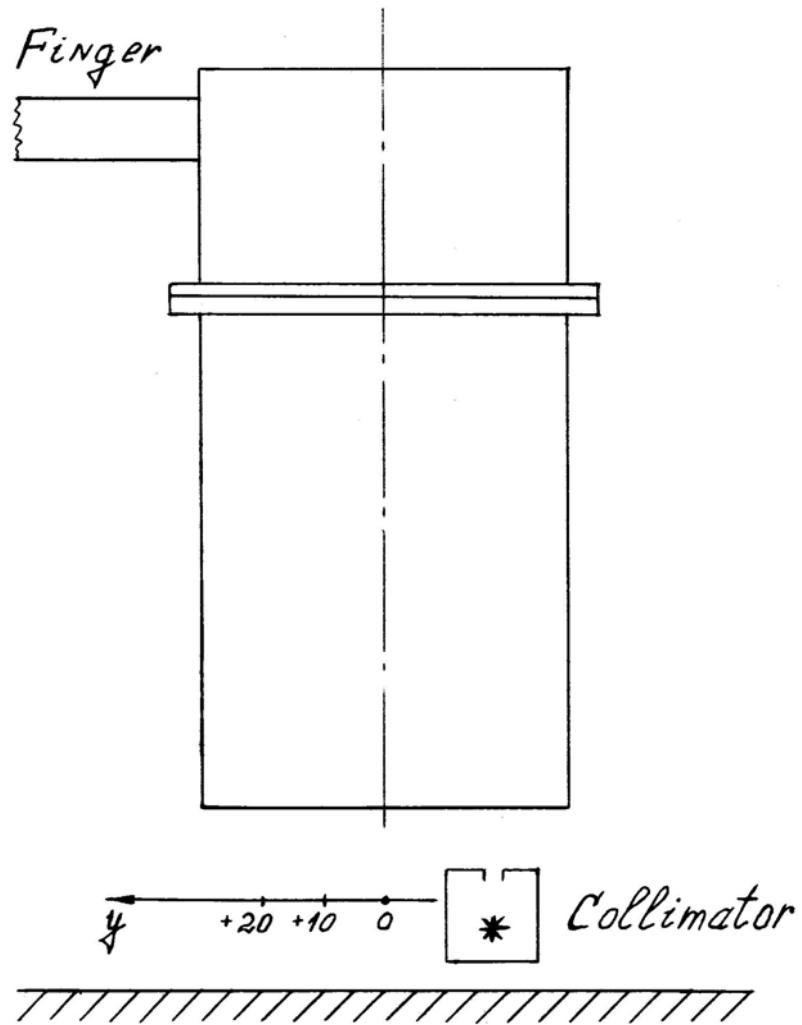

Figure 3: "Horizontal measurements".

Table 1: “Horizontal measurements”.

Coordinate	30	25	20	15	10	5	0	-5	-10	-15	-20	-25	-30	-35
Dead layer, mm	0.86	0.91	0.89	1.02	1.09	1.15	1.13	1.10	1.14	0.99	0.96	0.96	0.96	0.95
err.	0.14	0.15	0.15	0.19	0.21	0.22	0.21	0.21	0.22	0.19	0.18	0.18	0.18	0.18

The averaged thickness of a dead layer on the bottom of the detector:

$$d_{\text{bottom}} = (1.01 \pm 0.19) \text{ mm}$$

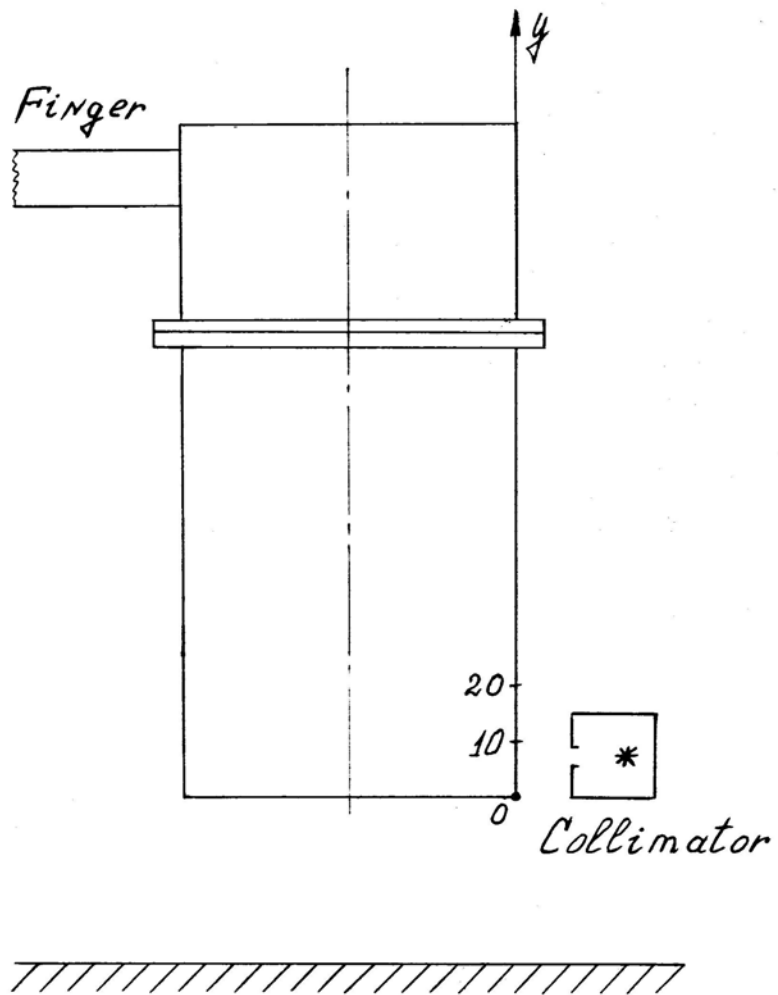

Figure 4: “Vertical measurements”.

Table 2: “Vertical measurements”.

Coordinate	97	96	95	94	93	92	91	90	85	80	75	70	65	60	55
Dead layer, mm	0.93	0.91	0.81	0.85	0.80	0.80	0.89	0.90	1.06	0.98	0.96	1.02	0.94	1.01	1.01
err.	0.14	0.17	0.10	0.14	0.15	0.11	0.13	0.15	0.20	0.19	0.18	0.19	0.18	0.19	0.19

Coord.	50	45	40	35	30	25	24	23	22	21	20	19	18	17
D.I., mm	1.04	0.97	0.94	0.92	0.90	0.86	0.81	0.82	0.80	0.90	0.92	0.84	1.01	1.07
err.	0.20	0.18	0.18	0.17	0.15	0.16	0.13	0.16	0.15	0.17	0.17	0.16	0.19	0.20

The averaged thickness of the dead layer
on the lateral surface:

$$d_{ls} = (0.95 \pm 0.17) \text{ mm}$$

- $M_{\text{act}} = 2025.29 \text{ g}$

- $M_{\text{full}} = 2152.3 \text{ g}$

- $M_{\text{act}} / M_{\text{full}} = 0.94$

- $M_{\text{eff}} / M_{\text{full}} = 0.87$

- - background measurements with the unshielded (outside of protection) detectors,
report at Milano Collaboration meeting 2006.

Changes in dead layer thicknesses of the IGEX detectors (preliminary results)

An analysis of low-energy parts of spectra provides possibility to observe small changes in the dead layer thicknesses. The next figure illustrates changes in spectra of the same detector with different thicknesses of the dead layer, $d=0.5$, 1.0 and 2.0 mm (the spectra were normalized to the data with $d=0$ mm).

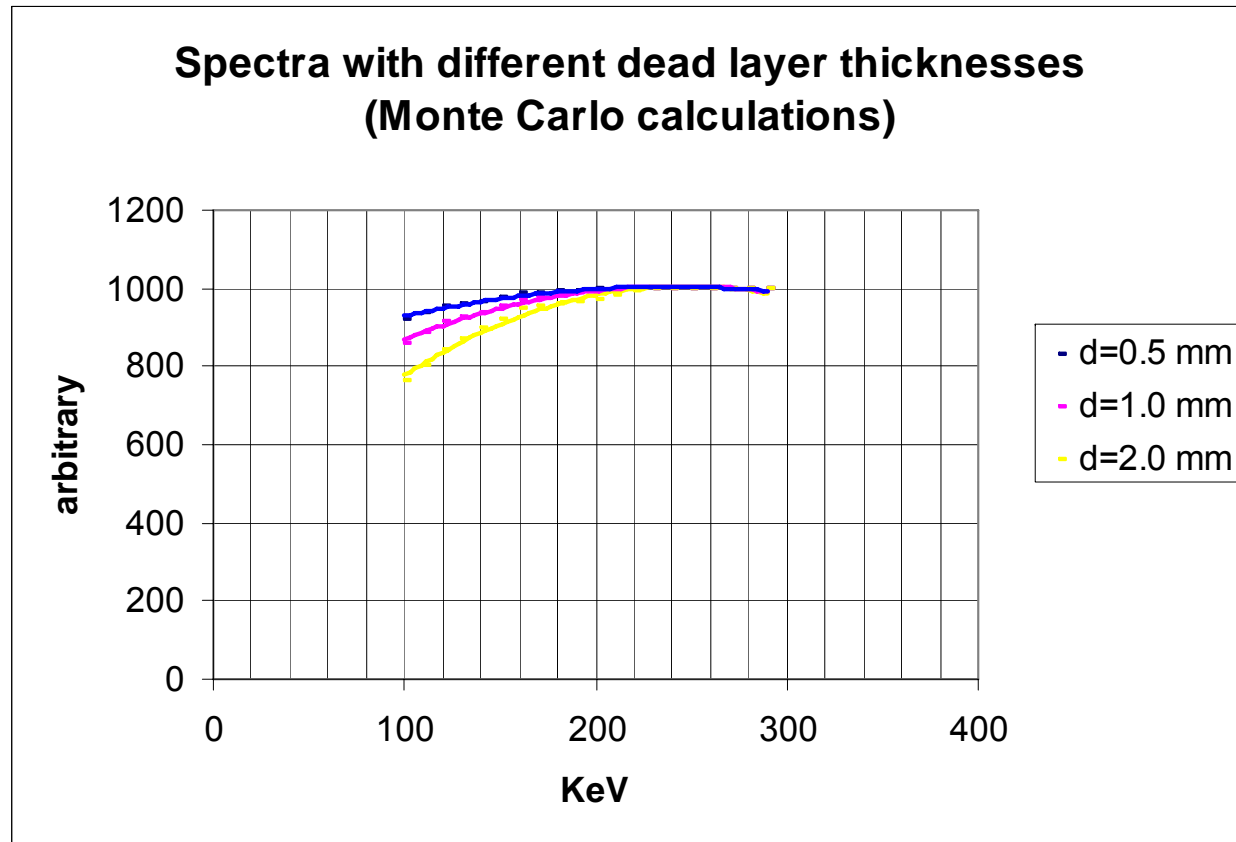

**Comparison of RG1 background spectra:
HST (1994) and Gran Sasso (2006)**

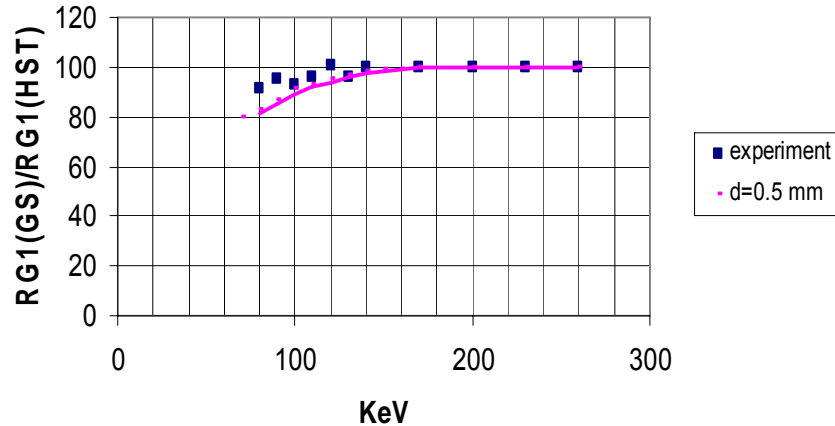

**Comparison of RG2 background spectra:
HST (1994) and Gran Sasso (2006)**

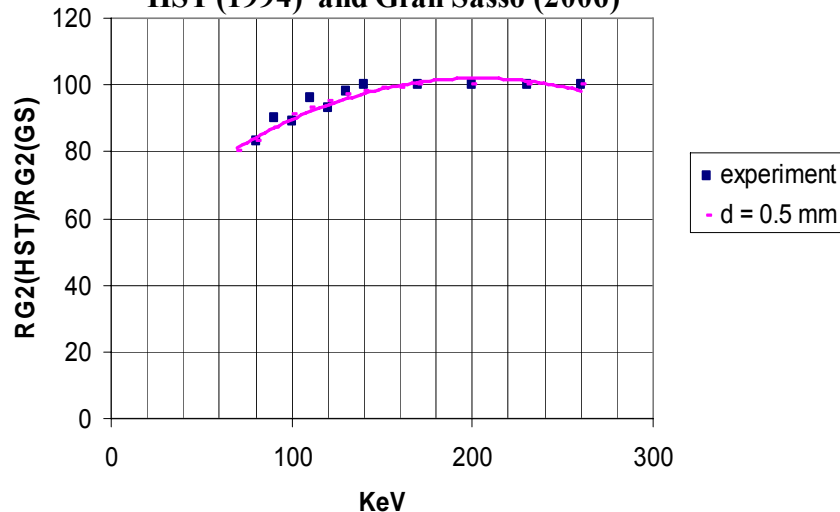

PRELIMINARY

To get the changes of dead layer on the surfaces of RG1 and RG2 we have compared our measurements with open RG1 and RG2 detectors in Homestake (1994) and the recent measurements in Gran Sasso (2006). Results are given in these two figures.

It should be pointed out, that uncertainties due to the possible difference in constructions of the detectors were absent in this case.

Measured increasing of the dead layers:

RG1 \approx (150 – 200) μ

RG2 \approx (450 – 500) μ

Measured dead layer of RG1

d = \sim 950 μ side surface

(800 μ - the passport value)

REFERENCES:

1. GERDA Scientific Technical Report **GSTR-06-004 February 7, 2006**
2. Background measurements with open IGEX and ANG 2 detectors: effective masses.
O. Chkvorets (MPIK), E. Demidova (ITEP), K. Gusev (RRC 'KI'), M. Junker (LNGS), I. Kirpichnikov (ITEP), V. Lebedev (RRC 'KI'), P. Pfeifer (MPIK), S. Schoenert (MPIK), M. Shirchenko (RRC 'KI'), A. Vasenko (ITEP). **Report at LNGS Collaboration meeting 2006.**
3. E. Demidova, I. Kirpichnikov, A. Vasenko. **In preparation.**
4. E. Demidova, I. Kirpichnikov, A. Vasenko. **Nucl. Phys., 1998, vol. 61, № 7, p. 1338.**